



MiniPID 2 (3PIN)

User Manual V1.6



EU Declaration of Conformity

The EU Authorised Representative of the manufacturer Ion Science limited has sole responsibility, on the date this product accompanied by this declaration is placed on the market, the product conforms to all technical and regulatory requirements of the listed directives

Authorised Representative: ISM Deutschland GmbH · Laubach 30 · D-40822 Mettmann, Germany
Product: MiniPID Std or MiniPID Reg Revision 2
Product Description: Intrinsically safe photo-ionisation sensor for volatile organic compounds
Directive ATEX Directive (2014/34/EU)
EMC Directive (2014/30/EU)

Type of protection:  II 1G Ex ia IIC Ga (-40 °C ≤ Ta ≤ +55 °C) @ 1.1W limitation
(-40 °C ≤ Ta ≤ +65 °C) @ 0.9W limitation

Certificate: Baseefa07ATEX0060U
Notified Body: SGS Fimko 0598
North American certifying authority: UL

North American File #: E344333

Standards

EN IEC 60079-0:2012+A11:2013 Electrical Apparatus for Potentially Explosive Atmospheres – General Requirement
EN IEC 60079-11:2012 Explosive Atmospheres - Equipment Protection by Intrinsic Safety ‘i’
EN IEC 61010-1:2010 Safety requirements for electrical equipment for measurement, control and laboratory use – General requirements

Other Standards

EN ISO/IEC ISO 9001:2015 Quality Management Systems – Requirements
EN ISO/IEC 80079-34:2020 Potentially Explosive Atmospheres – Application of Quality Systems

Name: Clemens A. Verley

Position: Chief Executive Officer



Signature:

Date: 31st December 2020

Content

EU Declaration of Conformity.....	2
Content.....	3
Statements	5
Responsibility for Use	5
Legal notice.....	5
Introduction.....	6
Features.....	6
Applications.....	6
Sensing Attributes.....	7
How MiniPID 2 works.....	7
Volatile organic compounds (VOCs) sensed by MiniPID 2	8
Response factors.....	8
Calculating the sensor responsivity to VOC mixtures	9
Mechanical Integration into Instruments	10
General considerations	10
Diffusive flow sampling instruments	10
Impressed Flow Sampling Instruments.....	11
Electrical requirements	13
Supply voltage	13
Supply current	13
Analogue output.....	14
Error states	14
Electromagnetic Noise Reduction.....	15
Use of the MiniPID 2 in intrinsically safe applications.....	16
Summary requirements	16
Intrinsically safe installation diagram.....	17
Equivalent Intrinsically Safe Circuit	17
Schematic block diagram of a MiniPID 2 sensor.....	18
Specifications.....	20
Sensor Dimensions.....	20
General Product Specifications.....	21
Electrical Specifications.....	21
Performance Specifications.....	21
Environmental	22

Temperature Sensitivity	22
Linearity.....	23
Sensitivity to humidity	24
Calibration Guidelines	26
Maintenance.....	27
Routine Maintenance	27
Unscheduled Maintenance.....	27
Removing the electrode stack and lamp.....	27
Inspecting the MiniPID 2 stack	28
Inspecting and cleaning the MiniPID 2 lamp	28
Assembly of MiniPID 2 electrode stack, lamp and body.....	29
Instrument Warranty and Service	30
Warranty	30
Service and service centres	30
Contact details	31
Spares	34
Manual log.....	35

Statements

Responsibility for Use

Inadequate performance of the gas detection equipment described in this manual may not necessarily be self-evident and consequently equipment must be regularly inspected and maintained. Ion Science recommends that personnel responsible for equipment use institute a regime of regular checks to ensure it performs within calibration limits, and that a record be maintained which logs calibration check data. The equipment should be used in accordance with this manual, and in compliance with local safety standards.

Legal notice

Whilst every attempt is made to ensure the accuracy of the information contained in this manual, Ion Science accepts no liability for errors or omissions, or any consequences deriving from the use of information contained herein. It is provided "as is" and without any representation, term, condition or warranty of any kind, either express or implied. To the extent permitted by law, Ion Science shall not be liable to any person or entity for any loss or damage which may arise from the use of this manual. We reserve the right at any time and without any notice to remove, amend or vary any of the content which appears herein.

Introduction

MiniPID 2 is a miniature photoionisation (PID) sensor, providing a voltage output which varies with concentration of predominantly volatile organic compounds (VOCs) received into the sensor's gas sensing enclosure *via* a PTFE filter membrane. The output voltage can be subsequently converted to indicate the concentration of target gases in convenient units, *e.g.* ppm or mg/m³.

The MiniPID 2 sensor is offered in seven models providing the measurement range shown below. All PIDs are exceptionally resilient to contaminating and humid environments, providing unparalleled performance in a variety of applications.

<i>Name</i>	<i>Photo-ionising energy</i>	<i>Range</i>	<i>Resolution</i>
MiniPID 2 PPM	10.6 eV	0 to >4,000 ppm	100 ppb
MiniPID 2 PPM WR	10.6 eV	0 to 10,000 ppm	500 ppb
MiniPID 2 PPB	10.6 eV	0 to >40 ppm	1 ppb
MiniPID 2 PPB WR	10.6 eV	0 to 200 ppm	20 ppb
MiniPID 2 PPB XF	10.6 eV	0 to 40 ppm	1 ppb
MiniPID 2 HS	10.6 eV	0 to >3 ppm	0.5 ppb
MiniPID 2 10.0 eV	10.0 eV	0 to >100 ppm	5 ppb
MiniPID 2 11.7 eV	11.7 eV	0 to >100 ppm	100 ppb

The significance of the photo-ionising energy presented above is discussed in the following sections. All ranges correspond to ppm isobutylene (CAS No. 115-11-7) in balance air at 20 °C and 1 atmosphere.

Features

- Patented 'fence electrode technology' for excellent humidity resistance
- Anti-contamination design
- Reliable lamp ignition – illuminates at low temperatures
- Superior lamp life – 10.6 and 10.0 eV => 10,000 hours
- User-replaceable electrode stack in event of corrosive or mechanical damage
- Intrinsically safe (ATEX, IECEx, _{us}ULc)
- Lamp out error detection (MiniPID 2 PPM only)

Applications

- Industrial hygiene & safety monitoring
- Soil contamination and remediation
- Hazmat sites and spills
- Leak detection
- EPA Method 21 and emissions monitoring
- Arson investigation
- Indoor air quality monitoring
- Outdoor air quality monitoring

Sensing Attributes

How MiniPID 2 works

The MiniPID 2 sensor measures volatile organic compounds (VOCs) in air by photoionisation detection (PID). The sensing mechanism is shown schematically below. Test gas (1) is presented to the external face of a porous membrane, through which it freely diffuses, into and out of a gaseous enclosure, (shown by double headed arrows). From the opposite face of the enclosure, (2) an illuminated lamp emits photons of high energy UV light, transmitted through a crystal lamp window (wavy arrows). Photoionisation occurs in the enclosure when a photon collides with a photoionisable molecule (3a) to generate two electrically charged fragments or ions, one positively charged, X^+ , and one negatively charged, Y^- (3b). These are separated at, oppositely charged metal electrodes, being a cathode and anode, generating a tiny electric current. The current is amplified in an electric circuit (not shown) and presented as a sensor voltage output which depends on the concentration of photoionisable gas. The MiniPID 2 includes a third fence electrode which ensures that the amplified current does not include significant contributions due to other current sources such as electrolytic salt films on the chamber walls.

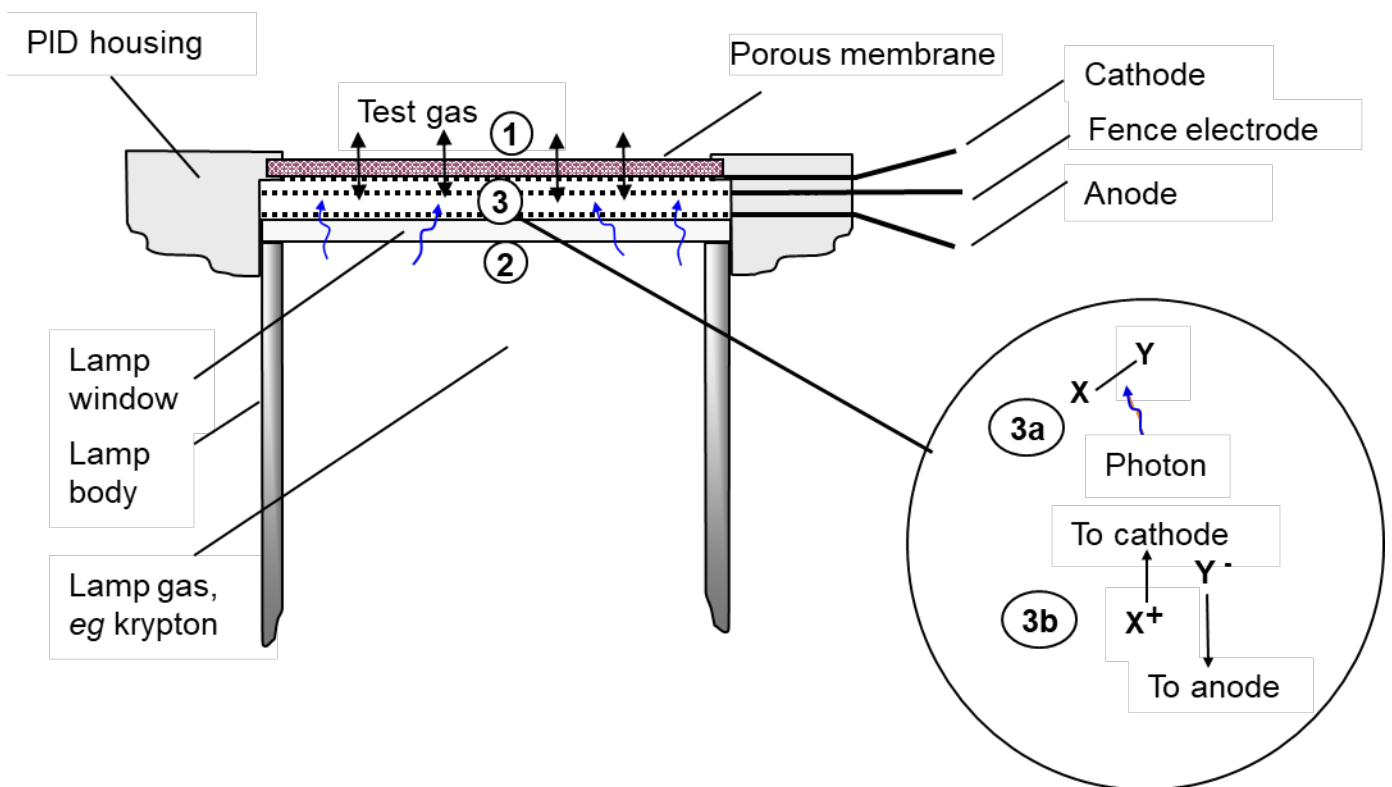

Volatile organic compounds (VOCs) sensed by MiniPID 2

Most VOCs can be detected by MiniPID 2. Notable exceptions are low molecular weight hydrocarbons.

Every VOC is characterised by an *Ionisation Energy* (IE). This is the minimum energy required to break the VOC into charged fragments or *ions*. Volatiles and gases in air are photo-ionised, and hence detected, when exposed to light of *photon energy* greater than their IE. MiniPID 2 is provided with a light source of three different photon energies: 10.0 eV, 10.6 eV or 11.7 eV.

Standard MiniPID sensors (PPM, PPB and HS) engage an unfiltered krypton light source, which delivers 10.6 eV UV light. The sensors respond to about 95% of volatiles, notable exceptions being most volatiles of one carbon atom, acetylene, ethane, propane and saturated (H)CFC's

The MiniPID 11.7 eV, which employs an argon lamp light source, responds to almost all VOCs: the few exceptions are methane, ethane and saturated fluorocarbons. 11.7 eV PID is less selective but particularly of interest in measuring formaldehyde, methanol and the lighter hydrocarbons, for which scant other sensing technology is available.

Finally, MiniPID 10.0 eV, which engages a krypton light source and a crystal filter, responds to more limited range of VOC's. Aromatics and most other unsaturated molecules are most readily detectable with this lamp, whereas most saturated hydrocarbons, with which they often occur, are sensed weaker or not at all.

For detection of a volatile compound, it must be sufficiently volatile. A fairly large molecule such as alpha-pinene, (a constituent of turpentine), saturates in air at about 5000 ppm at 20 °C; this is the maximum concentration of the alpha-pinene that can be measured at 20 °C. Some compounds, e.g. machine oils and plasticisers, generate a fraction of a ppm of vapour at ambient temperatures. Because the diffusion of such large molecules is also very slow, in most scenarios they are not detectable. Organic compounds of boiling points 275 to 300 °C (at 1 atm.) are considered to be semi-volatiles and marginally detectable. Compounds of boiling point > 300 °C are considered non-volatile and undetectable. For further information on the sensing capabilities of MiniPID 2 please refer to the technical application note library on our website.

Response factors

Our PIDs are calibrated using isobutylene, but PID is a broadband detection method with a variable sensitivity to each VOC. The relative sensitivity to each compound also varies significantly with PID photon energy (10, 10.6 or 11.7 eV). It varies much less with PID design and lamp output.

Response Factors (RFs) provide an indication of the relative sensitivity of PID to specific VOCs, relative to isobutylene. The RF of a VOC is used to convert the calibrated response of the sensor with isobutylene into a concentration of the target VOC.

Example: Toluene

- A MiniPID 2 10.6 eV sensor is calibrated with isobutylene and found to have a sensitivity of 1 mV ppm⁻¹.
- If the sensor is exposed to 100 ppm isobutylene the output will be 100 mV.
- The response factor for toluene using 10.6 eV is listed as 0.56.
- If the sensor is exposed to 56 ppm toluene then the displayed uncorrected concentration will be 100 ppm isobutylene. The corrected concentration would be 100 multiplied by the RF, 0.56, which gives the correct result of 56ppm toluene.

A complete list of response factors is available as Technical Article TA-02, in the document library of our website, www.ionscience.com. A searchable database of response factors and other information is available on our website under the heading “Gas Search”.

If response factors are programmed into an instrument, it is possible for target VOC to be specified, and the instrument can then display and record a concentration for that target volatile.

Calculating the sensor responsivity to VOC mixtures

A volatile organic compound, or VOC, is a carbon-containing chemical, which is significantly or completely vaporised at ambient temperatures.

Occasionally you will be measuring a mixture of VOCs. If the total concentration is within the linear range of the PID, then it is reasonable to assume that the concentrations are additive without interference between the different VOCs:

The correction factor for a gas mix containing PID detectable gases A, B, C... with response factors RF(A), RF(B), RF(C), in fractional proportions a:b:c is given by:

$$\text{RF mix} = 1/[a/\text{RF}(A) + b/\text{RF}(B) + c/\text{RF}(C)\dots]$$

Example:

A gas mix to be monitored contains 1 part isopropanol to 4 parts acetone:

Chemical name	RF	Fractional composition
Isopropanol	4.0	0.2
Acetone	1.17	0.8

Therefore the RF of the mix will be:

$$\begin{aligned} \text{RF mix} &= 1/[(4.0 / 0.2) + (1.17 / 0.8)] \\ &= 1/(0.8 + 0.936) \\ &= \mathbf{0.58} \end{aligned}$$

Important: remember that if you are measuring a combination of VOCs then accurate measurement of one of these VOCs will be difficult; without careful data analysis you will get only a RF averaged measurement. Also, note that in the volatilisation of mixtures of VOC's of different volatility, the more volatile fraction volatilises most rapidly, and the least volatile most slowly, leading to a change in the composition of the liquid and vapour mix.

Mechanical Integration into Instruments

General considerations

MiniPID 2 has the same dimensions as the standard 'series 4' electrochemical or LEL sensor. Thus, it is possible to plug the MiniPID 2 into a standard 20 mm diameter LEL sensor position and for the MiniPID 2 detector to operate correctly, provided the external signal conditioning circuitry can operate under the stated output specification range of the MiniPID 2.

Instrument design should ensure that the sensor's interconnect pins are fully seated, and that the sensor is not subject to displacement in its housing in the event of mechanical shock or vibrations liable to be encountered during the instrument's service.

Avoid materials liable to outgas VOCs in close proximity to the MiniPID 2. This is particularly important in instruments intended for ambient air monitoring, as discussed below.

Diffusive flow sampling instruments

MiniPID 2 is commonly incorporated into instruments in which ambient air accesses the sensor by free diffusion of air in contact with it. Such instruments are said to rely on *diffusive flow sampling*.

Diffusive flow sampling instruments vary widely in application. They include fixed (or 'wall mounted') detectors, some of which are designed to provide an early warning of the presence of an exceptional threshold concentration of a VOC, usually between 10 and 1000 ppm, such as may present an immediate health hazard or indication of fire risk. Other fixed detectors are intended to deliver regular measurements of ambient air quality.

Diffusive sample flow is also deployed in detectors worn by personnel. In this case, time weighted measurements of VOC's are of interest, typically at concentrations between 1 to 100 ppm, averaged over 15 min (STEL - short term exposure limit) or 8 hr (TWA – time weighted average). In most light industrial and domestic environments, the VOC concentration is typically 0.2 to 0.5 ppm isobutylene equivalent¹, which limits the practical minimum detection limit for a target VOC to 0.5 ppm isobutylene equivalent in these detectors.

Although such applications vary widely, in practice, the demands they make on MiniPID 2 sensor attributes are much the same: a rapid response to rapid positive and negative changes in VOC concentration.

The electrode stack includes an O-ring intended to provide a seal between the lamp and the stack. Carefully follow the section [Removing the MiniPID 2 electrode stack and lamp](#) to ensure the lamp and stack seals correctly.

It is important that instrument design, particularly in respect to sensor housing, does not deflect sample gas nor contribute more than a small fraction of a ppm to the sensor background. To this end, guidelines concerning MiniPID 2 incorporation into diffusive flow sampling instruments are provided as follows.

- If the MiniPID is deployed in a wall mountable detector, the sensor is ideally located in the instrument to be as far from the wall mountings as possible, to minimise condensation phenomena caused by the air vs wall temperature disparity (consider the accumulation of particulates and heavy volatiles on shelves and kitchen units).
- The sensor should be pointing downwards or sideways, to avoid slow accumulation of volatile in the sensor cavity, and dust.

¹ Throughout this discussion, unspecified concentrations in ppm refer to 10.6 eV PID measurements of isobutylene. Although 10.6 eV PID responsivity to volatiles varies widely, the average VOC responsivity of over 700 VOCs quoted by Ion Science is very similar to isobutylene (6% greater).

- Housing for the sensor is preferably made from a suitable metal. The sensor should be as exposed to the air as much as possible. Metallic grids serving to protect the sensor mechanically or from electromagnetic noise, should be maximally perforated and located against the sensor gas sensing face, see diagram below. *Note that grids and barriers placed more than a fraction of a millimetre from the sensor gas membrane will prolong the response time and the clear down time of the instrument to ambient sample gas.* Housing should provide free access of air to the sensing face of the sensor as much as possible.
- VOC outgas accumulates in the air space within instrument enclosures, for example from residual solvents in recessed conformal coatings. The effective diffusive flow of the gas to the instrument from the ambient environment may be only a fraction of a mL/minute, and therefore VOCs from instrument enclosure air space which can access the sensor by diffusion are of extreme importance. An encapsulated gasket or O-ring which makes a seal around the perimeter of the top face of the sensor is advantageous, see diagram.
- Seals or gaskets used to prevent an appreciable gaseous pathway between the sensor gas inlet and instrument interior should be closed cell foam or molded rubber which does not adsorb the VOCs which are targeted for measurement. For maximal avoidance of instrumental VOC background, use fluoro-elastomeric seals.

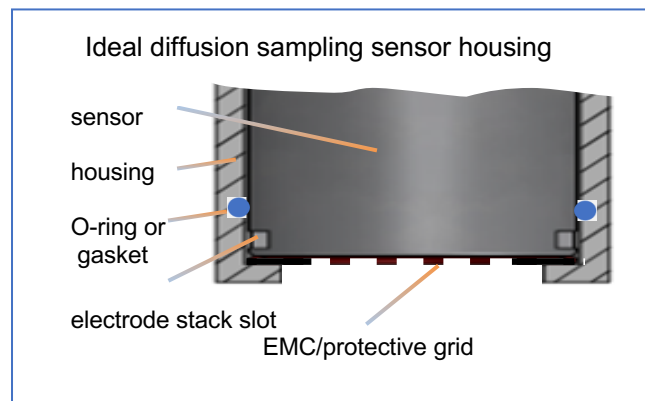

Impressed Flow Sampling Instruments

An instrument is often designed to convey a remote sample to a sensor. Usually, this *impressed flow sampling* is delivered by means of a pump through tubing sufficiently narrow to enable rapid transit of the gas from source to sensor, without causing pressure differentials which might compromise the sensor or the pump. The sample gas source may be from some confined space, or the headspace of a container, or the end of a VOC leak seeking probe. In such applications, the important attributes of the PID is rapid response over a wide dynamic range.

- As above, sensor housing should be preferably made from a metal or low permeability plastic. Exposure of the gas stream to sources of VOCs other than the sample gas itself should be minimized. Sample gas should be conveyed through stainless steel or plastic conduit of low VOC permeability. Avoid plasticized and highly elastic (soft) tubing.
- The MiniPID 2 is designed to provide a sealing area on the top face of the MiniPID 2 electrode stack. Ensure that the seal lies within the four segmented arcs visible on the front face. Typically, the seal can be affected with a fluoro-elastomeric O-ring or gasket of 6 mm ID and 9.0 mm OD. A seal of minimally 4 mm OD can be used to minimize dead space in tight tolerance designs.
- Note the sensor gas access port is off-centre. To avoid significant shear forces on the gas port O-ring or gasket, engage the seal with a screwed assembly.
- If gas sampling is so remote that it requires a pump near the source to deliver the flow downstream to the sensor, a flow of gas of no more than 500 mL/min (At 1 atm, 20 °C, 68 °F) is preferably teed off near to the sensor and directed across the sensor's gas sampling (top) face as shown in the diagram below. Note that exhaust gas should be conducted away from the sensor to ensure that the sensor does not appreciably sense air from the local environment in the prevailing sample regime. To avoid condensation, the pressure of gas above the sensor should not exceed a few mbar above ambient.

- If gas sampling is to be achieved by a pump within the sensing instrument, it is an advantage to place the pump downstream of the sensor so as to minimize VOC retention in the pump (slow clear-down following an episode of high VOC exposure). Flow rates of 50 to 500 mL/min are generally acceptable, and the gas differential at the sensor interface vs ambient does not exceed -10 mbar.
- By placing a pump upstream of a sensor, the gas sensing enclosure can be caused to be at a positive pressure relative to ambient, which is to be preferred in the event of significant pneumatic leaks, but often introduces VOCs into the test gas stream caused by VOC permeable pump internals.
- Note that any appreciable pressure differential between the gas presented to the PID and the pressure at source will lead to a corresponding increase in sensor responsivity (see Calibration). For a given pneumatic system, the effect of any occasionally deployed pneumatic restrictions such as additional filters or extended sample conduit on the pressure difference between ambient and the sensor interface should be considered.
- The PTFE filter on the PID is intended to prevent particulate access to the sensor. If the instrument is to be operated in atmospheres contain high concentrations of particulates, then a prefilter may be deployed at the gas source of the instrument.
- Impressed gas flow should be ideally presented to the sensor parallel to the gas sensing face, as shown below.

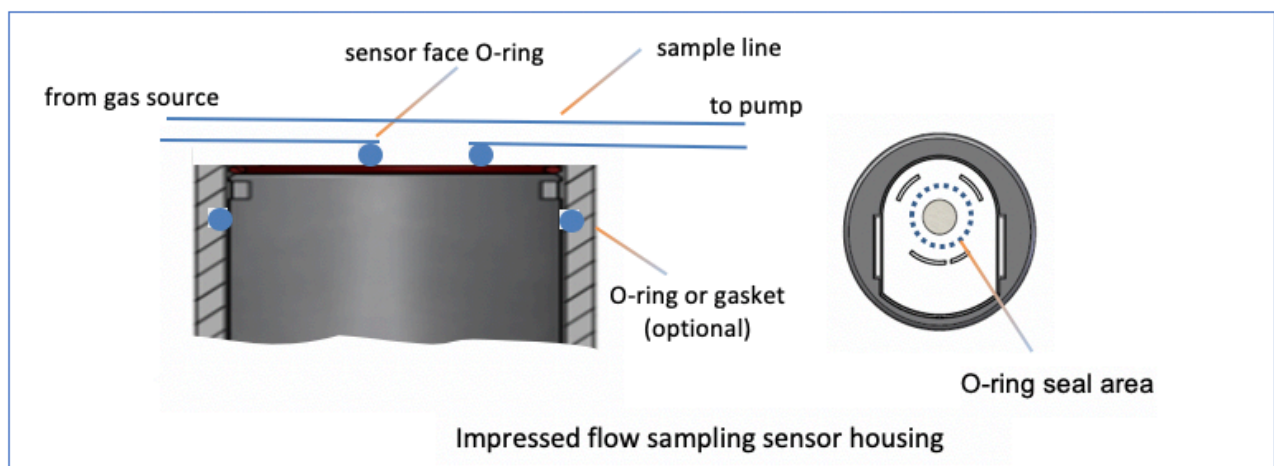

- In some specialized and chromatographic gas handling instruments, only a very low gas flow may be available to the PID. Inter-diffusive gas flow to and from the sensor through the membrane in the absence of impressed flow corresponds to 3 mL/min, so impressed gas flows lower than this are liable to cause an unstable response arising from ill-defined diffusion boundary conditions. This can be somewhat avoided by removing the PTFE filter from the sensor electrode stack with tweezers*. In that event, the response time of the sensor will be determined by the gas flow rate and combined dead volume of the upstream gas pneumatics and PID gas sensing enclosure. The latter is only 15 mm³.

** Important:*

The stack PTFE filter not only prevents particulates from entering and accumulating within the sensor's gaseous enclosure, but also contributes to the sensor's output stability and resilience to contamination. Removal of the PTFE filter is possibly acceptable only with certain pre-conditioned gas samples for which VOC concentrations are generally low and humidity is always non-condensing. It is not generally recommended. Contact Ion Science for further advice.

Electrical requirements

This section explains how to connect electrically the MiniPID 2 to your instrumentation. Please take careful notice of the requirements to power the sensor to meet intrinsic safety standards.

Supply voltage

MiniPID 2 is provided in an externally or internally regulated format. Please see *Product list* [Page 32] for the various options.

Externally regulated (defined as our 'standard sensor') sensors have a filled solder well on the base, and are available for supply voltages as follows:

$V_s = 3.0$ to 3.2 V (product numbers ending AU2)

$V_s = 3.2$ to 3.6 V (product numbers ending BU2)

These sensors must be supplied a stable source of voltage between 3.0 to 3.6 V (dependent on MiniPID type). The internal voltage rail is determined by the externally supplied voltage, affecting lamp illumination and other circuits, and therefore determining the sensor response. The use of an external voltage regulator allows the user to operate the sensor to their requirements.

Specifications are provided for externally regulated sensors at $V_s = 3.2$ V.

Internally regulated (defined as our 'regulated sensor') sensors have an open well on the base, and are available for supply voltages as follows:

$V_s = 3.6$ to 10.0 V used for intrinsically safe applications (product numbers ending CU2)

$V_s = 3.6$ to 18.0 V used for non-intrinsically safe applications (product numbers ending NU2)

The sensor output stability of these sensors is unaffected by external supply drift as the sensor circuits are internally regulated to 3.3 V and can be operated at any voltages specified above without change of performance.

The internally regulated sensors are very much unaffected by power variance and can tolerate up to 1 V changes at low frequency. The designer should however guard against high frequency ripple and transient spikes as these may not be totally suppressed by the internal regulator and filter circuits and could therefore adversely affect the operation of the sensor.

Important: enabling or disabling the internal voltage regulator will invalidate sensor warranty.

Always follow manufacturer's recommendations for their specific power supply regulators to ensure stable regulation, because poorly designed regulator circuits can in a few instances cause power rail resonance, especially at temperatures of less than -20 °C, -4 °F.

Supply current

The normal operational current of the MiniPID varies with supplied voltage, typically from 20 mA at 3.0 V to 32 mA at 3.6 V. However, to aid effective lamp-strike at power-up, the circuit has been specifically designed to deliver a higher voltage to the lamp ignition circuits for a short period of time, thus requiring a start-up current of typically 130 mA for 100 ms.

Analogue output

For all externally regulated sensors (part number *AU2, *BU2) the output voltage range is from 0.0 V to ($V_s - 0.1$) V.

For all internally regulated sensors (part number *CU2, *DU2), the output voltage range is 0.0 to 3.2 V.

The operating sensor output signal zero is set at +50 mV for the following reasons:

- to provide optimal input bias current characteristics
- to enable external amplifiers to operate at inputs above 0 V
- to provide a 0 to 50 mV window for error status sensor output voltages

Error states

Voltages below 50mV indicate the following fault conditions:

Output voltage (mV)		Fault Condition	Recommended Action
PPM sensors (MP3SMMLL*)	All other sensors		
32 ± 1	n/a	Lamp not illuminated	Change or clean lamp
		Electrode stack not fitted correctly	Ensure electrode stack is fitted correctly
27 ± 1	41 ± 3	Oscillator not working	Change MiniPID
		Misplaced electrode stack	Change electrode stack
18 ± 2	25 ± 2	Oscillator overloaded	Change electrode stack and/or MiniPID
2 ± 2	2 ± 2	Power removed	Check OEM supply voltage

Notes:

Voltages outside these limits are not rigorously defined. It is suggested that as a first action the electrode stack should be replaced when an error state occurs.

The sensor output error voltages given are for an unloaded PID output. If the PID is connected to a low input impedance circuit, then the output voltage will be reduced accordingly. The DC output impedance is 6.3 kΩ, see [Equivalent Intrinsically Safe Circuit](#).

Electromagnetic Noise Reduction

To minimise EMC noise and maximise MiniPID 2 voltage output stability it is recommended that supporting electronics are configured to minimise susceptibility to EMC noise. This is particularly important in instruments which are liable to encounter electromagnetic noise, such as detectors which are handheld or worn by personnel.

Preferably,

- Signal lines are located close to the ground plane, balanced and directly coupled to a differential input analogue-to-digital Converter (ADC) or differential input amplifier.
- A separate signal 0V line is connected directly to the 0V pin of the PID and runs parallel with the signal line to the differential input ADC or amplifier. This single pair of signal lines are located between two ground planes or run for its full length directly over the top of a ground plane.
- Since the PID responds in 50-100 ms, an RC network is included on both signal lines located directly at the input of the differential input ADC or amplifier to remove 100Hz (and higher frequency) noise.
- While the MiniPID 2 has its own internal screening, it is possible to achieve maximal noise reduction if the entire MiniPID 2 sensor is mounted within a Faraday cage in the form of a perforated metal screen placed over the sensor (see *Mechanical integration into instruments*), which should be electrically connected to the ground plane.

Specific to the MiniPID 2 PPM sensor, electrical currents in the order of sub-picoamps generated within the photoionisation enclosure are monitored by the internal electronics to diagnose any “lamp-out” occurrence. Any capacitive coupled EMC discharge on an ungrounded case/covering can be transmitted to these circuits and cause a false “lamp not illuminated” error message to be registered, giving a +32 mV sensor output error state. The duration of the error will be dependent upon the severity of the close-coupled EMC discharge. The error state is self-resetting, so in the absence of EMC interference normal operation will resume. The lamp out diagnostic cannot be avoided, other than by appropriate screening. To screen the sensor from this noise, it must be protected by an electrically grounded Faraday cage, whose location is identified in *Mechanical integration into instruments*.

Use of the MiniPID 2 in intrinsically safe applications

Summary requirements

1. External supply surge current must be limited to 3.3 A under fault conditions.
2. In order to meet the power requirements required for intrinsic safety at higher temperatures, it may be advantageous to incorporate a resistor in series with a 125 mA fuse in the supply line.
3. Take note of the various maximum supply voltages that may become connected to any of the pins under fault conditions.
4. Take note of the power limits of the various pins under fault conditions.
5. The capacitance is low and should not cause problems at these voltages.
6. If processing electronics are in another zone, then barrier/segregation resistors are required in any signal lines.
7. Competent third-party assessment is required on the final product.
8. MiniPID 2 configured for IS regulation with V_s of 3.6 to 10 V (product codes ending CU2), when operated at V_s approaching 10 V, should have signal and power rails infallibly isolated to ensure the summed capacitances on an external short circuit do not exceed the safety current limit.

When the sensor is to be engaged in intrinsically safe circuits, it is very important to abide by the stated temperature, power, voltage and current ratings.

The intrinsically safe MiniPID 2 sensor is designed to drop into a standard LEL sensor position. However, LEL sensors take considerable current and are often zoned by a separate 125 mA fuse and other suitable upstream voltage limiting devices. Depending upon the current required by the monitoring electronic circuits the MiniPID 2 may either share the same zoned 125 mA fuse or the electronics can be in another zone whose power is supplied by another fuse. If two zones are required, then very low current signals may be passed between the two zones by isolating resistors to limit any potentially shared high current between the two zones thus maintaining separate zone integrity.

Intrinsically safe installation diagram

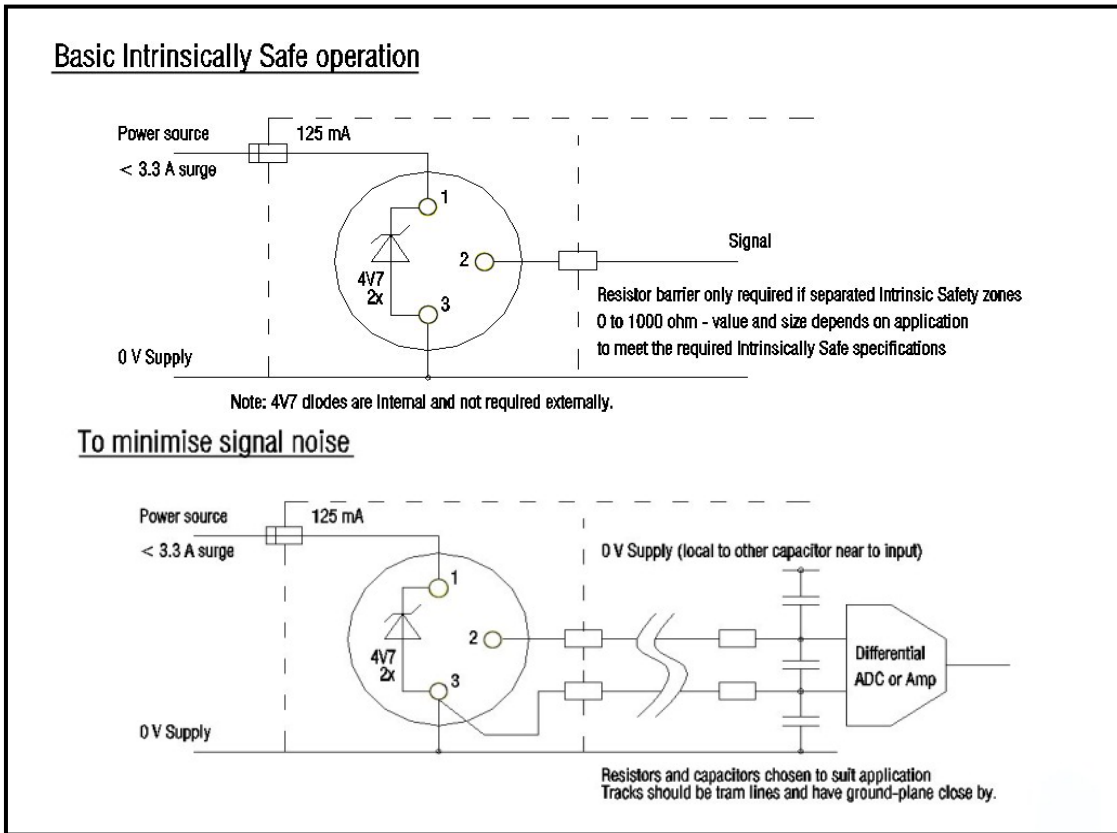

Equivalent Intrinsically Safe Circuit

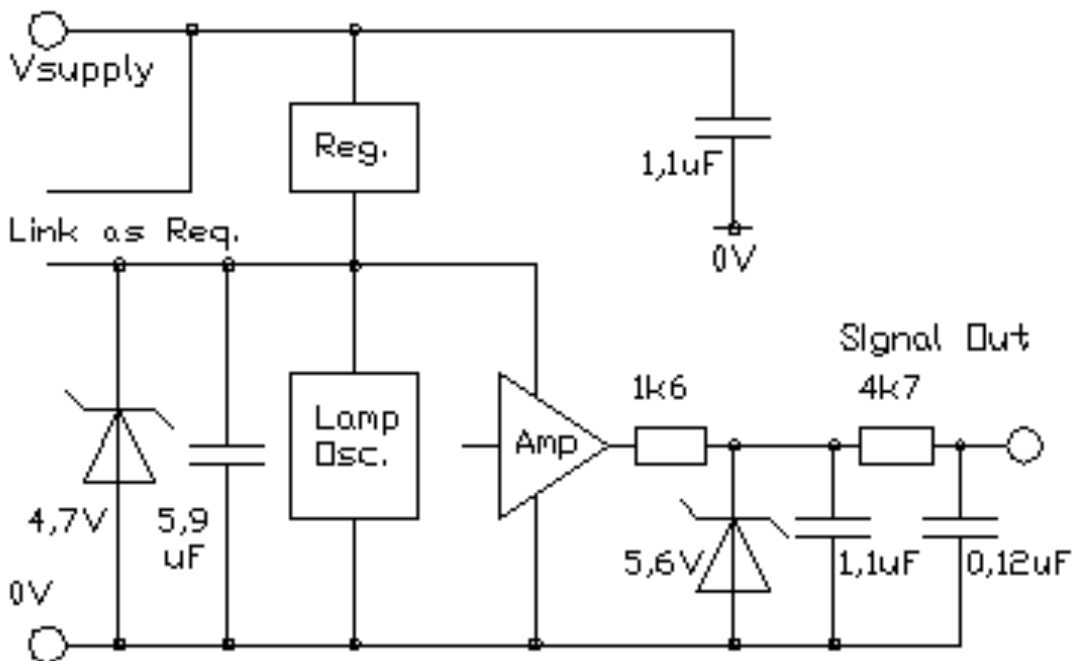

Schematic block diagram of a MiniPID 2 sensor

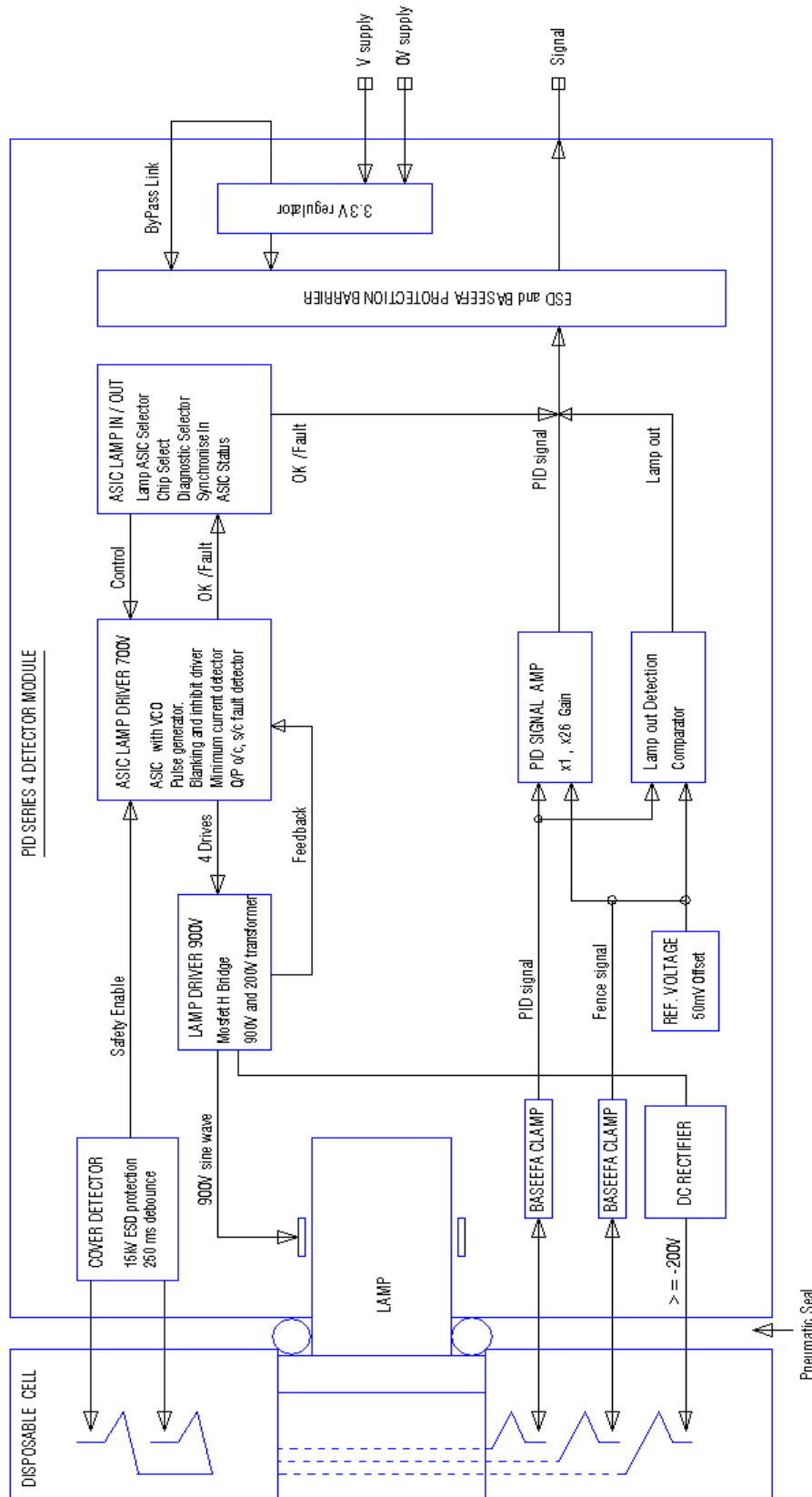

Supplementary Intrinsicly Safe Specifications:
Approval

ATEX Approved Baseefa 07ATEX0060U	UL	Class 1 Div 1 Groups A, B, C, D
IECEX Approved BAS07.0030U		Conforms to UL standard 913
 II 1G Ex ia IIC Ga		Certified to CSA standard C22. 2 No. 157
Eurasian Customs Union		№ EAЭC RU C-GB.HA65.B.00635/20

Temperature range

-40 °C ≤ Ta ≤ 55 °C
(note: Pi where Ta may be taken to 65 °C)

Supply Voltage on pin 1 Ref to 0 V on pin 3
MiniPID Standard (with solder blob)

Voltage (Max)	Ui	6.0 V
Current continuous (Max)	Ii	220 mA
Power (Max)	Pi	1.1 W @ +55 °C, 1.0 W @ 60 °C; 0.9 W @ 65 °C;
Current surge (Max)	Surge	< 3.3 A
Capacitance (Max)	Ci	7.0 μF
Inductance (Max)	Li	0 μH

MiniPID Regulated (without solder blob)

Voltage (Max)	Ui	10.0 V
Current continuous (Max)	Ii	220 mA
Power (Max)	Pi	1.1 W @ +55 °C, 1.0 W @ 60°C; 0.9 W @ 65°C;
Current surge (Max)	Surge	< 3.3 A
Capacitance (Max)	Ci	1.1 μF
Inductance (Max)	Li	0 μH

Voltage on Signal Output pin 2 Ref to 0 V on pin 3

Voltage (Max)	Ui	10.0 V
Current continuous (Max)	Ii	10 mA
Power (Max)	Pi	50 mW
Capacitance (Max)	Ci	0.12 μF
Inductance (Max)	Li	0 μH

Note: "Signal Output pin 3" Ci to be summed with "Supply Voltage pin 1" Ci above (not countable fault)

Special Conditions of Use

1. The component must be mounted within apparatus which provides ingress protection of at least IP20, protection against impact, and protection against possible electrostatic charging of the plastic enclosure.
2. No conductive surfaces or items to be mounted within 10mm of the end cap (sensor face) unless either separated by 1mm of solid insulation or connected to the 0V of the supply to the Component.

Warning:

The MiniPID sensor is an Intrinsicly Safe device that contains limited energy storing components. An appropriate Intrinsicly Safe interface must be employed for use in hazardous locations noting power limitations and temperature ranges and must be installed in strict accordance

Specifications

Sensor Dimensions

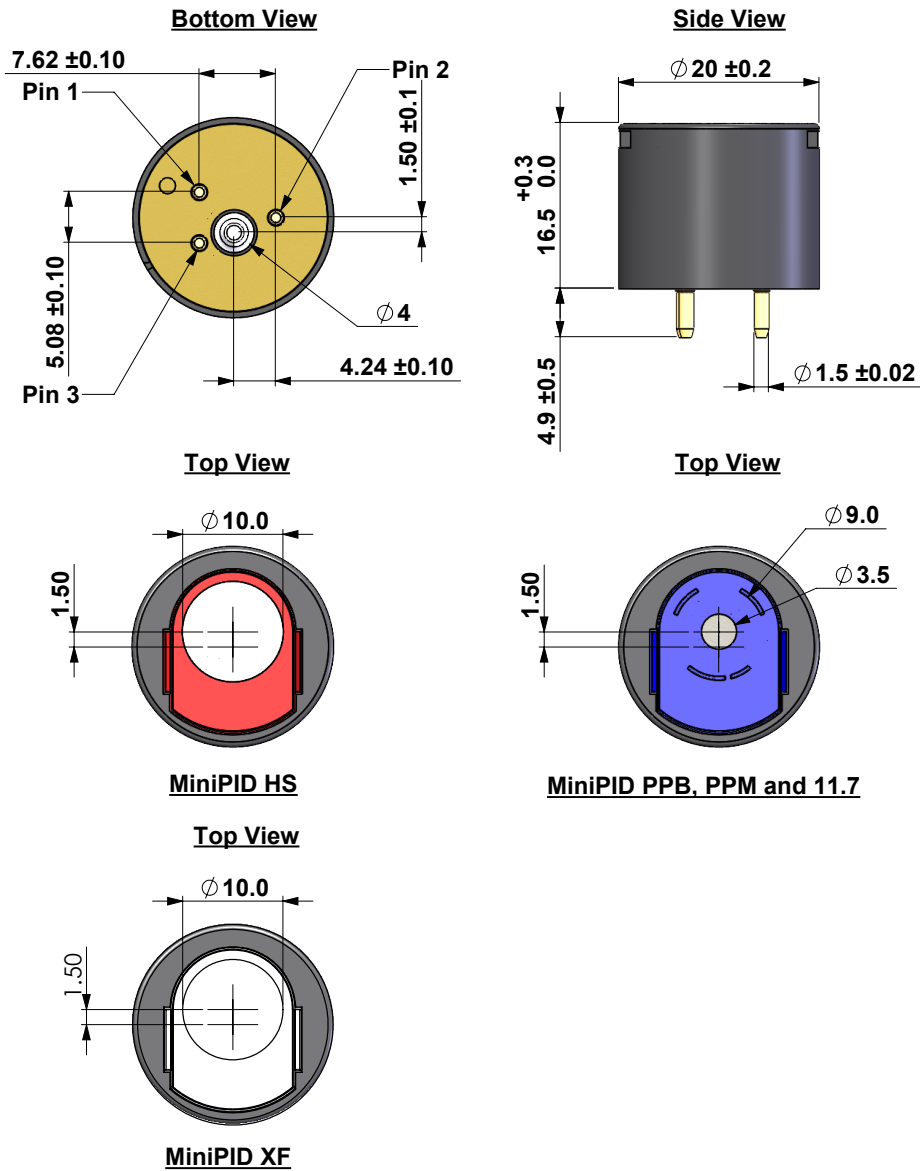

Outside dimensions and pin configuration as per industry standard series 4 LEL sensor.
Dimensions in mm.

- Pin 1 Positive Supply Voltage
- Pin 2 Sensor Output
- Pin 3 0V Ground

General Product Specifications

Lamp replacement	User replaceable
Electrode stack	User replaceable
On board filter (within disposable electrode stack)	Removes liquids and particulates
Package Type	Alphasense™ CH-A3, City Technology™ 4P, 20 mm dia x 16.6 mm high
Weight	< 9 g
Positional Sensitivity	None
Warranty	12 months from date of shipment.
(Please see page 30 for details on extended warranty)	
Patents	US 7,046,012 EC 1474681

Electrical Specifications

Supply Voltage on pin 1. Ref to 0 V on pin 3.

MiniPID 2 external regulation supply	V_S	3.3 V+ 0.3 V / - 0.1 V stable (noise free).
Current (at $V_S = 3.3$ V, 20 °C)	I_S	22 mA to 28 mA at $V_S = 3.3$ V,
Power consumption (at $V_S = 3.3$ V)	P	100 mW (typical)
Peak current at power-up	I_M	130 mA for 0.1 s maximum.

MiniPID 2 external regulation supply	V_S	3.6 V to 18 V (Non-IS) (variable) maximum.
Current drawn	I_S	30 mA \pm 3 mA (independent to V_S)
Current Consumption Drift	$I_{\Delta T}$	1.5 mA/10°C typical

Voltage on Signal Output pin 2. Ref to 0 V on pin 3.

Linear signal output:	V_{SO}	> 50 mV to regulated V_S (less 0.1V)
Stepped error states:	V_{EO}	< 40 mV
Output capacitance:	C_O	1.0 μ F through 4k7 Ω + 0.11 μ F at pin
Output resistance:	R_O	6k3 Ω
Output clamp:	V_{OC}	5V1 zener protected by 4k7 Ω resistor.

Performance Specifications

For optimal performance, Ion Science recommends an operational voltage of 3.3 V, at which the following specifications apply.

MiniPID 2	PPM WR	PPM	PPB WR	PPB
Minimum detection limit	500 ppb	100 ppb	20 ppb	1ppb
Range	>10,000 ppm	>4000 ppm	>200 ppm	>40 ppm
Sensitivity	>0.4 mV/ppm @ 100 ppm	>0.65 mV/ppm @ 100 ppm	>5 mV/ppm	>30 mV/ppm
Response time in diffusion mode (T90)	< 3 s	< 3 s	< 8 s	< 8 s
Offset voltage in clean air	51 to 65 mV	51 to 65 mV	51 to 80 mV	51 to 80 mV

MiniPID 2	PPB XF	HS	10 eV	11.7 eV
Minimum detection limit	1ppb	0.5 ppb	5 ppb	100 ppb
Range	>40 ppm	>3 ppm	>100 ppm	>100 ppm
Sensitivity	>30 mV/ppm	>600 mV/ppm	>15 mV/ppm	>1 mV/ppm
Response time in diffusion mode (T90)	< 12 s	< 12 s	< 8 s	< 8 s
Offset voltage in clean air	51 to 80 mV	100 to 200 mV	51 to 80 mV	51 to 90 mV

Environmental

Relative humidity range	0 to 99% RH, non-condensing
Operating Temp Range	-40 °C to +55 °C (intrinsically safe); -40 °C to +65 °C (non-IS)
MiniPID HS recommended operating temperature range	0 – 40 °C (see technical note TA-14 for more information)

Temperature Sensitivity

The results presented below are normalised for Gas Law (T=293 K) and apply to all sensor types. ± 2 SD is shown.

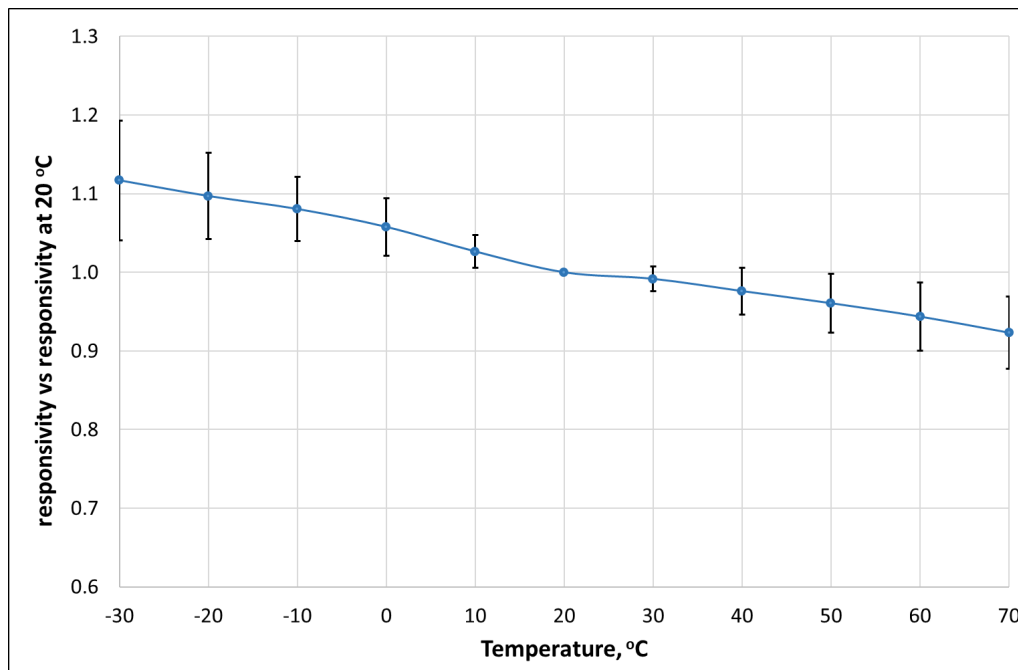

Linearity

The ppm sensor output is non-linear at high concentrations. Typical linearity of 10 sensors is shown in the graph below.

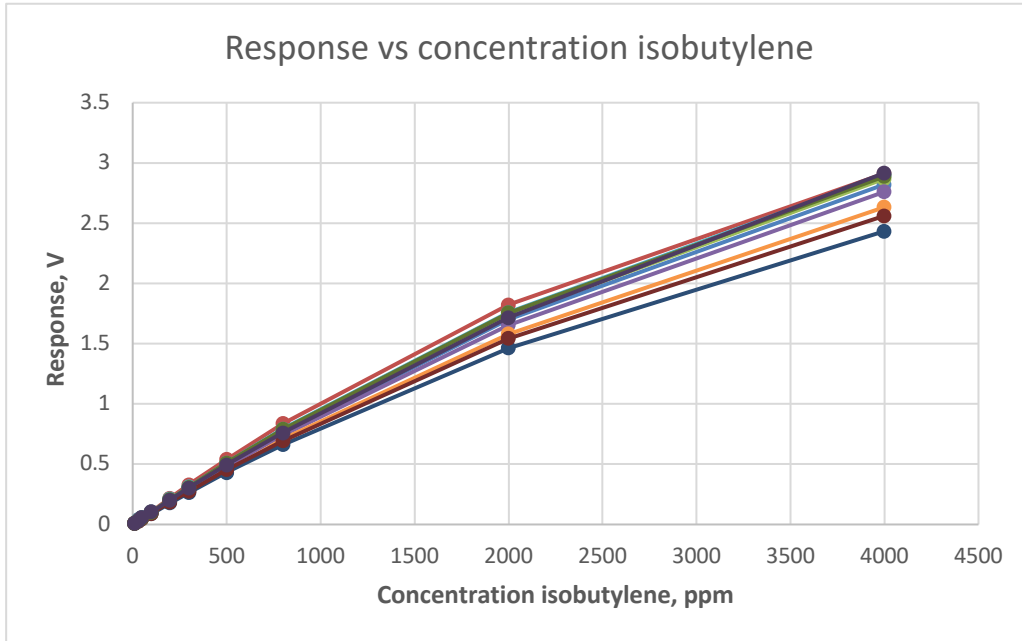

The ppm WR sensor output is non-linear at high concentrations. Typical linearity of 10 sensors is shown in the graph below.

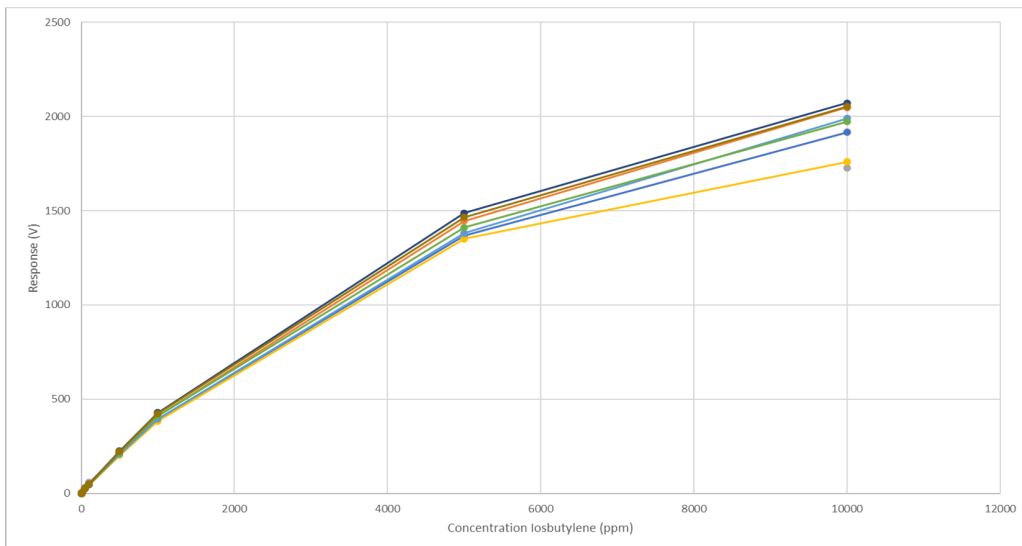

Sensitivity to humidity

Water vapour is not itself detected by MiniPID 2, but water vapour adsorbs a portion of the light that otherwise promotes a response from a photoionisable gas. The extent of signal attenuation depends primarily on the electrode stack used.

The figures presented below indicate how the signal may be attenuated for the MiniPID 2 PPM, PPB and HS electrode stacks as the relative humidity increases. Note how the response loss due to humidity increases with temperature, due to the increase in saturation vapour pressure (i.e. ppm concentration carried at RH = 100%) with temperature. The effect of water on attenuating signal is not dependent on the target sensed volatile. It is weakly dependent on lamp light intensity.

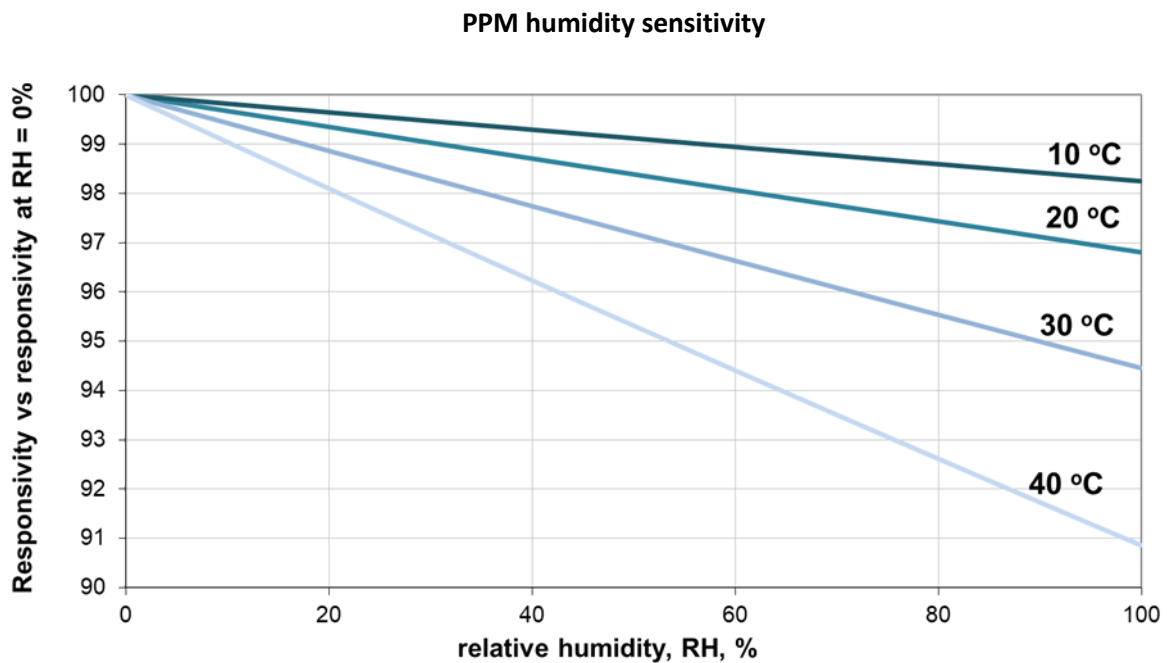

Typical MiniPID 2 PPM sensor responsivity vs relative humidity, RH

PPB humidity sensitivity

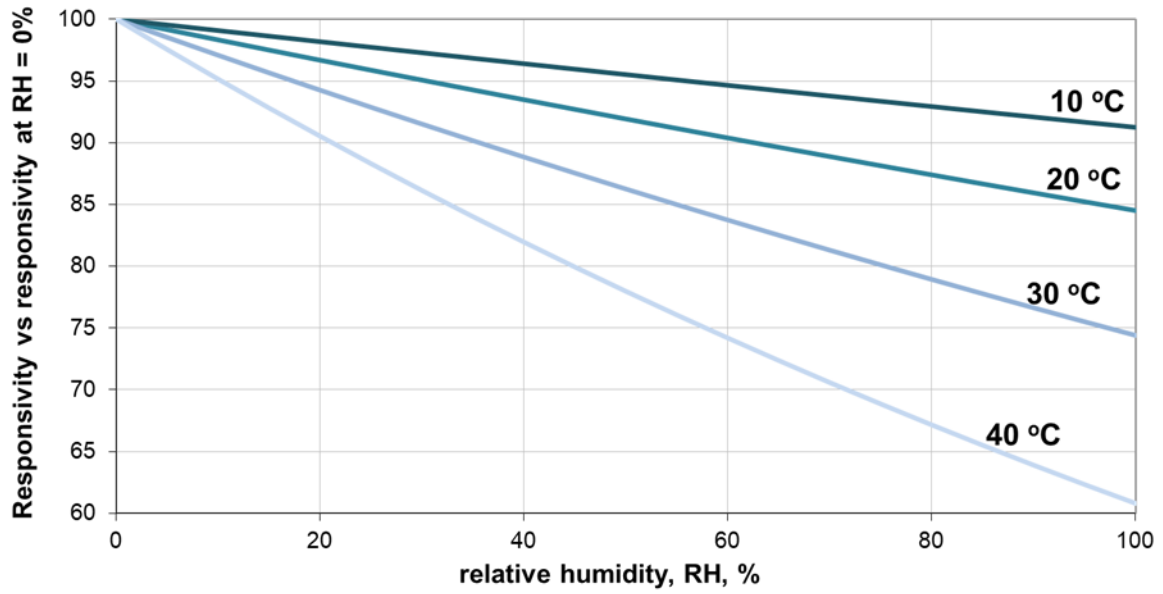

Typical MiniPID 2 PPB sensor responsivity vs relative humidity, RH

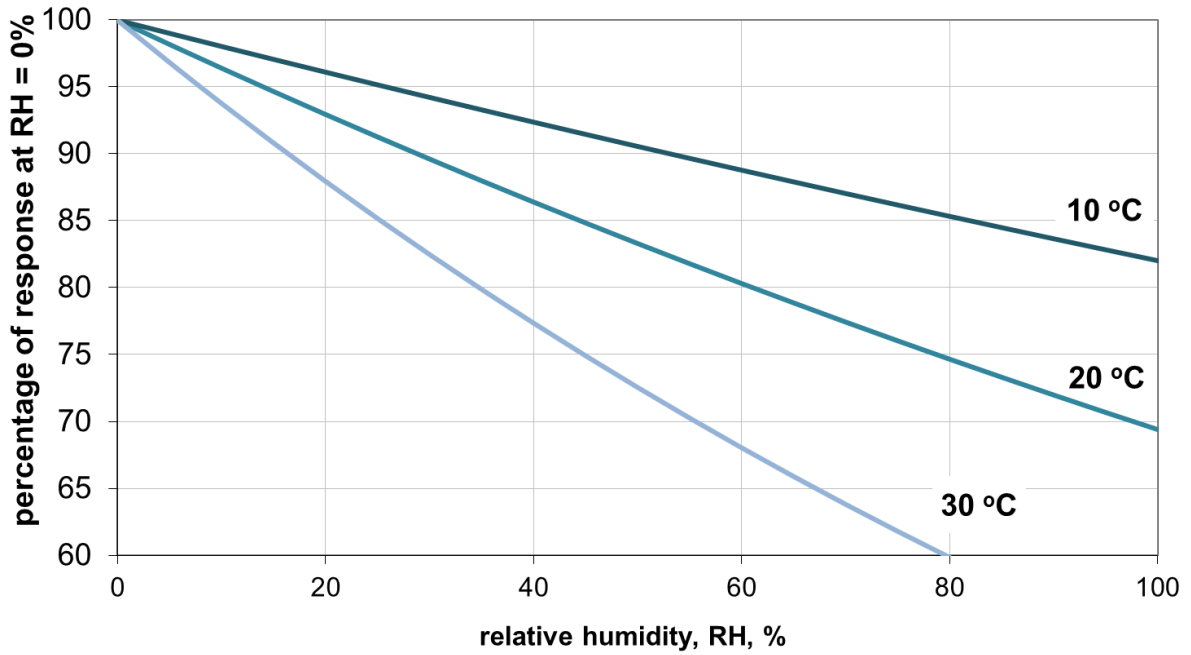

Typical MiniPID 2 HS sensor responsivity vs relative humidity, RH

Calibration Guidelines

MiniPID 2 naturally produces ozone in air, which over time acts to remove organic detritus from within the PID cavity. In many domestic and light industrial environments, the MiniPID 2 is self-cleaning. Re-calibration is then only needed to adjust for any decay in the PID lamp output on which the photoionisation measurement depends. In a fixed instrument, typically this will be every one to two months of cumulative sensor operation. However, when first deploying a PID instrument in a new environment, end users should be encouraged to bump test and re-calibrate as necessary. Since portable PID instruments are exposed to unknown environments, their calibration may be required more often.

Calibration of instruments containing MiniPID 2 usually demand measurements of 'zero gas', containing near zero concentrations of VOCs, and a span gas, used to calibrate the PID sensor in its linear range. Both gases are usually prepared with a 'balance' gas of artificial air, comprising ~80% nitrogen and ~20% oxygen. Do not use pure nitrogen as a balance gas as this delivers up to 20% more responsivity than air.

Appropriate end user calibration gases for the various MiniPID 2 sensors are identified below:

MiniPID 2:	Range	recommended zero gas max. VOC	recommended span gas isobutylene content	notes
PPM	>4000 ppm	1 ppm	100 ppm isobutylene	Certain applications may call for higher calibration point(s)
PPM WR	>10,000 ppm	1 ppm	100 ppm isobutylene	
PPB	>40 ppm	0.1 ppm	30 ppm isobutylene	
PPB WR	>200 ppm	0.1 ppm	30 ppm isobutylene	
PPB XF	>40 ppm	0.1 ppm	30 ppm isobutylene	See notes on zero gas measurement
HS	>3 ppm	0.1 ppm	2 ppm isobutylene	
10 eV	>100 ppm	0.1 ppm	100 ppm isobutylene	
11.7 eV	>100 ppm	0.1 ppm	100 ppm propane	Isobutylene can be used

Zero gas of <0.1 ppm VOC is usually provided by ultrahigh purity (UHP) air. To enable frequent calibration, purified gas systems providing the same gas purity can be used. Lubricating oils in compressed air lines should be avoided as they will foul PIDs if exposed to the gas stream for extended times.

Some gases absorb UV light without causing any PID response (*e.g.* methane, ethane). In ambient atmospheres where these gases are present the measured concentration of target gas will be less than is present. Methane absorbs UV strongly, so for accurate measurements in methane containing atmospheres, calibrate with a calibration gas containing the expected methane concentration.

The HS sensor requires particular care in handling as identified in the technical article TA-14. Since air may contain semi-volatiles which give rise to a significant and slowly moving sensor response, calibration of a high sensitivity VOC detector must always be undertaken after burn-in using clean air. This will provide the zero point calibration reading.

Maintenance

Routine Maintenance

The electronics in the MiniPID 2 sensor are not accessible and designed to be maintenance-free.

The electrode stack is easily replaced and inexpensive. The MiniPID stack will operate for years in most non-corrosive environments. It is recommended that end users of instruments containing MiniPID 2 carry at least one electrode stack in stock. The electrode stack is not toxic. Due procedures should be considered for safe disposal in the event of the stack being exposed to toxic environments.

Unscheduled Maintenance

The MiniPID should be dismantled and stack and lamp inspected in the following circumstances:

- On exposure of the sensor to very humid, acidic (sour) and salty environments. This may cause inorganic salts to accumulate on PID enclosure walls, which ultimately compromises the screening potential of the MiniPID 2 fence electrode. This is often indicated by a moisture sensitive signal.
- Visual indications of liquid ingress into the electrode stack.
- A sensor error state of 32 mV indicates a failure of contact has developed between the sensor pins and the stack pads. The wings on the MiniPID 2 stack may fail after repeated dis- and re-assembly. It may also be caused by failure of the stack to engage fully with the sensor body, which may be corrected by refitting the lamp and stack.

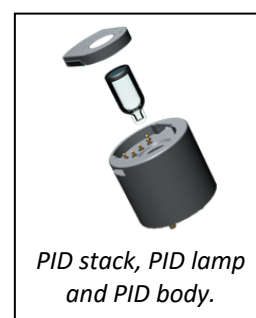

The MiniPID lamp should be cleaned and replaced as necessary if the responsivity of the sensor, as measured in bump tests or during calibration, decreases unexpectedly. Note that exposure of the sensor to amines is liable to temporarily contaminate the PID lamp. Instrument design should cater for this.

Removing the electrode stack and lamp

CAUTION: Only use the electrode stack removal tool. Any other tools (for example screwdrivers) may damage your MiniPID 2 body and will invalidate your warranty.

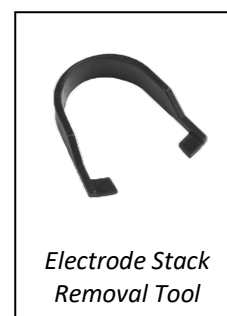

1. Wear gloves. Carefully remove the sensor from instrumentation.
2. Locate electrode stack removal tool in the side slots of the MiniPID 2 and squeeze together until electrode stack and lamp are released.
3. Lift carefully the MiniPID 2 body away from the electrode stack and lamp.
4. Occasionally the lamp may be temporarily lodged in the sensor body and will need to be freed carefully with tweezers. Occasionally the small spring behind the lamp will come out when the lamp is removed from the sensor. Simply replace it into the sensor body.

Inspecting the MiniPID 2 stack

On removal of the electrode stack, carefully inspect the underside. The visible electrodes should be shiny and metallic. If there are any signs of corrosion or water ingress the stack should be replaced.

Inspecting and cleaning the MiniPID 2 lamp

NOTE: Alumina polishing of lamps described below is appropriate for all MiniPID 2 lamps except the MiniPID 2 11.7 eV lamp.

Inspection of the MiniPID 2 lamp, as shown in the illustration, may reveal a fine film of contamination on the lamp window. However, it should be noted that window contamination is frequently not visible. Black or metallic deposits on the interior face of the lamp cannot be removed. If the deposits are extensive, the lamp must be replaced.

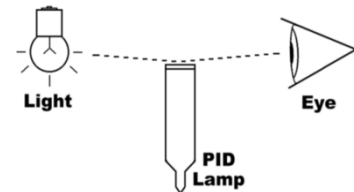

To clean the lamp, use of MiniPID 2 lamp cleaning kit A-31063. Validity of lamp warranty is compromised if lamp cleaning maintenance is not followed and lamp has obvious fouling/contamination.

1. Wear gloves. Never touch the lamp window, even with gloves.
2. Open the container of alumina polishing compound.
3. With a clean cotton bud, collect a small amount of the powder.
4. Use this cotton bud to polish the PID lamp window. Use a circular action, applying light pressure to clean the lamp window. Do not touch the lamp window with fingers.
5. Continue polishing until an audible “squeaking” is made by the cotton bud moving over the window surface. Usually this requires 15 to 30 s polishing.
6. Remove the residual powder from the lamp window with a clean cotton bud. Care must be taken not to touch the tips of cotton buds that are to be used to clean the lamps.
7. Ensure the lamp is completely dry and all detritus is removed before reassembling the lamp stack and body (see below).
8. Re-assemble the sensor lamp, stack and sensor body as described below, and reinstall sensor in the instrument.
9. Bump test the sensor. If the responsivity has recovered, then recalibrate the instrument. If not, replace the lamp.



CAUTION: The lamp cleaning kit contains alumina (CAS Number 1344-28-1) as a very fine powder. Cleaning should be undertaken in a well-ventilated area. A full material safety data sheet MSDS is available on request from Ion Science Ltd. Key safety issues are identified below:

Hazard identification:

- May cause irritation of respiratory tract and eyes

Storage:

- Keep container closed to prevent water adsorption and contamination.

Handling:

- Do not breathe in the powder. Avoid contact with skin, eyes and clothing
- Wear suitable protective clothing
- Follow industrial hygiene practices: Wash face and hands thoroughly with soap and water after use and before eating, drinking, smoking or applying cosmetics.
- The powder carries a TVL(TWA) limit of 10 mg/m³

Assembly of MiniPID 2 electrode stack, lamp and body.

CAUTION: Do not assemble using a damaged lamp as this may rupture the stack's lamp O-ring seal.

1. Lay the electrode stack front face down on a clean, flat surface and then screw the lamp down into the O-ring until it firmly abuts against the front electrode face.
2. Place the PID body carefully down over the lamp-stack sub-assembly so as not to disturb its seating within the electrode stack and then push the body firmly onto the face down electrode stack so that both wings engage with the PID body.
3. Inspect the sensor to confirm that both wings of the electrode stack have engaged with the PID body.
4. Refit the sensor into the sensing instrumentation.
5. Re-calibrate the equipment in accordance with manufacturer's instructions.

Instrument Warranty and Service

Warranty

The standard warranty on a MiniPID 2 is 12 months.

Full details, along with a copy of our Warranty Statement can be found by visiting: www.ionscience.com

Service and service centres

Ion Science is pleased to offer a number of service options for our MiniPID 2 product range that allows you to choose the cover that best suits your needs.

Contact Ion Science or your local distributor for service options in your area.

Find your local distributor by visiting: www.ionscience.com

Contact details

ION Science Ltd – UK/Head Office

Tel: +44 (0)1763 208 503

Web: www.ionscience.com | Email: info@ionscience.com

ISM ION Science Messtechnik – Germany Office

Tel: +49 (0) 2104 1448-0

Web: <https://www.ism-d.de/en/> | Email: sales@ism-d.de

ION Science India - India Office

Tel: +914048536129

Web: www.ionscience.com/in | Email: kschhari@ionscience.com

ION Science Inc – USA Office

Tel: +1 877 864 7710

Web: <https://ionscience.com/usa/> | Email: info@ionscienceusa.com

ION Science Italy - Italy Office

Tel: +39 051 0561850

Web: www.ionscience.com/it | Email: info@ionscience.it

ION Science China - China Office

Tel: +86 21 52545988

Web: www.ionscience.com/cn | Email: info@ionscience.cn



MiniPID 2 Comparison Chart and Accessories



MiniPID 2 model	Sensor part number	Sensitivity	Range	Lamp eV			Supply Voltage (V)				Intrinsically safe	Spare part numbers			
				10.0 eV	10.6 eV	11.7 eV	3.0 to 3.2	3.2 to 3.6	3.6 to 10.0	3.6 to 18.0		Lamp	Electrode stack	Colour	
MiniPID 2 HS	MP35HLH5AU2	0.5 ppb	>3 ppm		X			X				X	LA45X13.0	A-8466995	
	MP35HLH5BU2				X				X			X	LA45X13.2	A-8466995	
	MP35HLH5CU2				X				X			X	LA45X13.6	A-8466995	
	MP35HLH5NU2			X						X		LA45X13.6	A-8466995	Red	
MiniPID 2 PPB	MP35BLBAU2	1 ppb	>40 ppm		X			X				X	LA45X13.0	A-846267	
	MP35BLBBU2				X				X			X	LA45X13.2	A-846267	
	MP35BLBCU2				X				X			X	LA45X13.6	A-846267	
	MP35BLBNU2			X						X		LA45X13.6	A-846267	White	
MiniPID 2 PPB WR	MP35WBLBAU2	20 ppb	>200 ppm		X			X				X	LA45X13.0	A-846267	
	MP35WBLBBU2				X				X			X	LA45X13.2	A-846267	
	MP35WBLBCU2				X				X			X	LA45X13.6	A-846267	
	MP35WBLBNU2			X						X		LA45X13.6	A-846267	White	
MiniPID 2 PPB XF	MP35BLBXAU2	1ppb	>40ppm		X			X				X	LA45X13.0	A-846920	
	MP35BLBXBU2				X				X			X	LA45X13.2	A-846920	
	MP35BLBXC2				X				X			X	LA45X13.6	A-846920	
	MP35BLBXNU2			X						X		LA45X13.6	A-846920	White + Filter	
MiniPID 2 PPM	MP35MLLAU2	0.1 ppm	>4000 ppm		X			X				X	LA45X13.0	A-846486	Blue
	MP35MLLBU2				X				X			X	LA45X13.2	A-846486	
	MP35MLLCU2				X				X			X	LA45X13.6	A-846486	
	MP35MLLNU2			X						X		LA45X13.6	A-846486		
MiniPID 2 PPM WR	MP35WMLLAU2	0.5 ppm	>10000 ppm		X			X				X	LA45X13.0	A-846486	Blue
	MP35WMLLBU2				X				X			X	LA45X13.2	A-846486	
	MP35WMLLCU2				X				X			X	LA45X13.6	A-846486	
	MP35WMLLNU2			X						X		LA45X13.6	A-846486		
MiniPID 2 10.0eV	MP35BL0AU2	5 ppb	>100 ppm		X			X				X	LA45X13.0	A-846417	White + gold dot
	MP35BL0BU2				X				X			X	LA45X13.2	A-846417	
	MP35BL0CU2				X				X			X	LA45X13.6	A-846417	
	MP35BL0NU2			X						X		LA45X13.6	A-846417		
MiniPID 2 11.7 eV	MP35B7BAU2	0.1 ppm	>100 ppm					X				X	LA45W700	A-846267	White
	MP35B7BBU2								X			X	LA45W700	A-846267	
	MP35B7BCU2								X			X	LA45W700	A-846267	
	MP35B7BNU2									X		LA45W700	A-846267		

EURASIAN CUSTOMS UNION CERTIFIED SENSORS			
Model	Intrinsically Safe	Supply Voltage	Order code
PPM	✓	3.0 - 3.2 V	MP3RMLLAU2
	✓	3.2 - 3.6 V	MP3RMLLBU2
	✓	3.6 - 10 V	MP3RMLLCU2
PPM WR	✓	3.0 - 3.2 V	MP3RWMLLAU2
	✓	3.2 - 3.6 V	MP3RWMLLBU2
	✓	3.6 - 10 V	MP3RWMLLCU2
PPB	✓	3.0 - 3.2 V	MP3RBLBAU2
	✓	3.2 - 3.6 V	MP3RBLBBU2
	✓	3.6 - 10 V	MP3RBLBCU2
PPB WR	✓	3.0 - 3.2 V	MP3RWBLBAU2
	✓	3.2 - 3.6 V	MP3RWBLBBU2
	✓	3.6 - 10 V	MP3RWBLBCU2
10 eV	✓	3.0 - 3.2 V	MP3RBLOAU2
	✓	3.2 - 3.6 V	MP3RBLOBU2
	✓	3.6 - 10 V	MP3RBLOCU2

Spares

846216 Extraction tool required for replacing bulb or electrode stack



846600 Replacement spring



A-31063 PID lamp Cleaning Kit



Manual log

Version number	Update	Page	Date
V1.0	Manual updated in line with new product Declaration of conformity page updated		15/02/2016
V1.1	IECEX changed to IECEx to match brochure Product part numbers Lamp part number	Various 9 26	29/06/2016
V1.2	Corrected response factor calculation Updated to include 3.0 to 3.2 V and 3.2 to 3.6 V product Parts list updated	8 Various 26	03/10/2016
V1.3	Electrode stack Front cover image Declaration of conformity Introduction How does it work? Physical properties diagram Suggested pneumatic installation and diagram Power-up surge statement Error state table High background statement IS specification Specification table Selection chart Accessory list Disclaimer added	Various 1 3 6 7 9 10 13 13 15 18 19 26 27 28	15/03/2016
V1.3R	Logo only	1	01/08/17
V1.3	Declaration of Conformity Detection range Detection range	3 6 19	5/03/18
V1.4	Detection range change to > than Sensitivity changed to > than Declaration of Conformity China and France office Reformat Clarified wording Ui standard sensor change to 6.0 V Tolerances added to dimension diagram	Various Various 25 All All Various 25	11/11/19
V1.5	Russian Certification added Put into new design MiniPID 2 PPM WR and MiniPID 2 PPB WR added Declaration of conformity update		09/12/2020
V1.6	MiniPID 2 PPB XF added		05/03/2024

Disclaimer: Information in this user manual is subject to change without notice and does not represent a commitment on the part of Ion Science. No claims, promises or guarantees are made about the accuracy, completeness, or adequacy of the information contained herein.