



ARA-X Docking Station

User Manual V1.2



Contents

Safety	4
Legal Notices Regarding the Safe Operation of Equipment	4
Symbols	4
Warnings, Cautions and Information notifications	4
Disposal	5
Device Overview	6
Hardware Overview	6
Care and Operating Guidelines	7
Normal Operating Conditions	8
Prepare the ARA-X Docking Station for test	8
Equipment Installation	8
Battery Charging.....	9
Calibration Gas Installation	9
Set Ventilation Flow Path	10
Operate the ARA-X Docking Station	11
Power on/off the ARA-X Docking Station.....	11
Start Tests	11
Equipment Maintenance and Service	14
Device Configuration	16
Description of device configuration	16
Detector Configuration	Error! Bookmark not defined.
Description of Toxic sensor configuration.....	Error! Bookmark not defined.
Description of O2 sensor configuration	Error! Bookmark not defined.
Description of LEL sensor configuration.....	Error! Bookmark not defined.
Logs Report.....	Error! Bookmark not defined.
Maintenance Log.....	Error! Bookmark not defined.
Overall Test Log.....	Error! Bookmark not defined.
Event Log.....	Error! Bookmark not defined.
Cal Log.....	Error! Bookmark not defined.
Bump Log	Error! Bookmark not defined.
Datalog	Error! Bookmark not defined.
Test Report Log	Error! Bookmark not defined.



FW Upgrade.....Error! Bookmark not defined.
Technical Specification.....Error! Bookmark not defined.
TroubleshootingError! Bookmark not defined.
Limited Warranty.....**28**
Certifications / Approvals:**28**
Contact Information**29**

Safety

Legal Notices Regarding the Safe Operation of Equipment

- Whilst every attempt is made to ensure the accuracy of the information contained in this manual, ION Science accepts no liability for errors or omissions in the manual, or any consequences deriving from the use of information contained herein. It is provided “as is” and without any representation, term, condition or warranty of any kind, either expressed or implied.
- To the extent permitted by law, ION Science shall not be liable to any person or entity for any loss or damage which may arise from the use of this manual.
- We reserve the right at any time and without any notice to remove, amend or vary any of the content which appears in this manual.

Symbols



WARNING!
USED TO INDICATE DANGER WARNINGS WHERE THERE IS A RISK OF INJURY OR DEATH.



Caution
Used to indicate a caution where there is a risk of damage to equipment.



Information
Important information or useful hints about usage.



Recycling
Recycle all packaging.



WEEE Regulations
Ensure that waste electrical equipment is disposed of correctly.

Warnings, Cautions and Information notifications

The following Cautions apply to the product described in this manual.



This Equipment must be operated and serviced by qualified personnel only. Read the ARA-X Docking Station Manual and follow all instructions to ensure safe use.









Do not use the ARA-X Docking Station if it appears to be damaged. Inspect it before each use.



Do not remove the ARA-X4 while the bump test or calibration is in progress.



Do not charge the battery in HAZARDOUS location.

	Do not use the ARA-X Docking Station in a hazardous environment. The ARA-X Docking Station must be attached to a venting system or be used in a well-ventilated area.
	Do not expose the ARA-X Docking Station to electrical or mechanical shocks before, during, or after use.
	Do not allow liquids to enter the dock or into the flow path.
	Ensure the ARA-X Docking Station is used with certified calibration gas.
	Do not use expired calibration gas.
	Do not attempt to disassemble, adjust, or service the equipment unless instructions are provided to perform a procedure in this manual.
	Do not charge the battery in temperatures above or below the specified range of 5°C to 40°C

Disposal

- The equipment does not include any toxic materials, but if it has been contaminated by toxic materials, then exercise due care and follow the appropriate regulations when disposing.
- Always adhere to local regulations and procedures when disposing of the equipment.
- ION Science Ltd, offers a take back service. Please contact us for more information.



RECYCLING

This instrument contains a lithium-ion battery. Dispose of lithium cells immediately. Do not disassemble and do not dispose of in fire. Do not mix with the solid waste stream. Spent batteries should be disposed of by a qualified recycler or hazardous materials handler



WEEE REGULATIONS

Ensure that electrical equipment is disposed of correctly.

Device Overview

The ARA-X Docking Station is an automatic test and calibration station for use with portable gas detectors “ARA-X4”. The ARA-X Docking Station performs essential procedures for maintenance of gas detectors including Bump test, Calibration, Buzzer test, LED test and Log data transfers, by button operation. The ARA-X Docking Station can test multiple gases by 3 inlets.

The ARA-X Docking Station may be used as an individual, stand-alone test station. It contains an internal battery and can operate without any external power source. The ARA-X Docking Station can be connected to the PC via the “ARA-X Manager” software application to manage the ARA-X Docking Station and ARA-X4 settings, such as changing test configurations and upgrading FW.

Hardware Overview

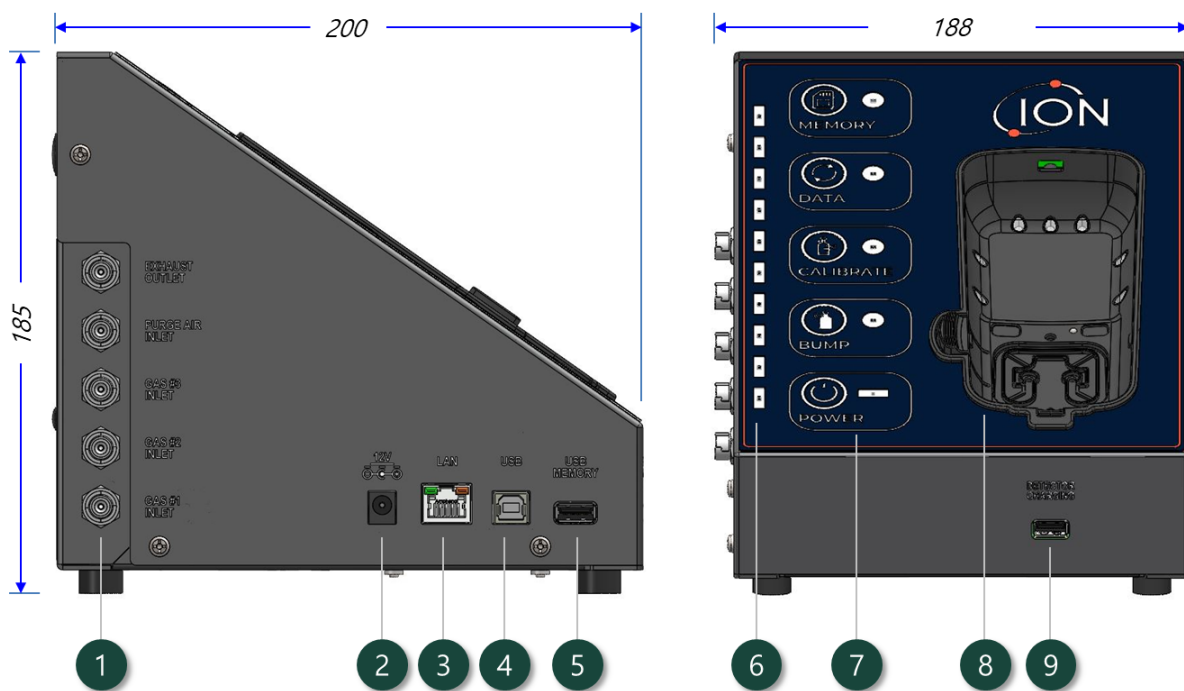

- | | |
|---|--|
| <ul style="list-style-type: none"> 1. Tube Couplers 2. DC JACK (12Vdc) 3. LAN Port 4. USB-B for PC 5. USB-A for Memory Stick | <ul style="list-style-type: none"> 6. 10 LEDs for progress indication 7. 5 Buttons and 5 LEDs for operation 8. Test Bay 9. USB-A for ARA-X4 charging |
|---|--|

1. Hose Barb Couplers	Five tube couplers (Hose Barb 1/8") 1) Exhaust Outlet - Gas exhaust for use in Bump test and Calibration 2) Purge Inlet - Supplies clean air for use in Bump test and Calibration 3) GAS #1 to #3 Inlet - Supplies Gases for use in Bump test and Calibration
2. DC Jack	DC Power Jack Use only the 12Vdc, 1.5A AC/DC adapter included in the product
3. LAN Port	RJ45 receptacle with 2 LEDs. LEDs indicate Link and Active status. The ARA-X Docking Station has AUTO-MDIX functionality, so both Cross / Straight cable can be used.
4. USB-B for PC	The USB 2.0B connector is used to connect the PC to the ARA-X Docking Station. Connect the ARA-X Docking Station and PC with a USB-B cable to configure, control and back-up the logs with 'ARA-X Manager' SW. *The ARA-X Docking Station is recognized as a COM Port device on the PC.
5. USB-A for Memory Stick	The side USB connector uses a memory stick only.
6. 10 LEDs for progress indication	The 10 LEDs located on the front side can light up red and green, and are used to display progress when the product is operating.
7. 5 Buttons and 5 LEDs for operation	Press the corresponding button to execute the following operations: 1) DATA - Data transfer from ARA-X4 to ARA-X Docking Station. 2) MEMORY – Backed up to USB memory of FW upgrade. 3) BUMP - Start Bump test 4) CALIBRATION - Start calibration When pressing the DATA, MEMORY, BUMP, or CALIBRATION buttons, the LEDs turn Red, Green, or Orange depending on status. 5) POWER – Power ARA-X Docking Station On/Off When ARA-X Docking Station is powered on, the POWER LED will be Blue or White. White: Battery Powered Blue: DC Powered
8. Test Bay	Test bay is the shape of the ARA-X4. Insert ARA-X4 here and perform a bump test or calibration, and to communicate with the device.
9. USB-A for Charge	The front USB connector is used to charge ARA-X4 only. This USB-A for charge port only has 5Vdc power. Charge the ARA-X4 by connecting the provided USB charger cable.

Care and Operating Guidelines

Use the following guidelines to enhance personal safety and protection of the ARA-X Docking Station and working environment. The unit should be serviced by qualified personnel only. Contact ION Science Ltd for troubleshooting, examination, or repair.

The ARA-X Docking Station is equipped with a fixed-voltage power supply and will operate at 12Vdc. To help protect ARA-X Docking Station from sudden, transient increases or decreases in electrical power, use a surge suppressor, line conditioner, or uninterruptible power supply (UPS).

To reduce the risk of electric shock or fire:

- Do not connect or disconnect any cables to or from ARA-X Docking Station during an electrical storm.

- Do not expose ARA-X Docking Station to rain or moisture.
- Do not push any objects into the openings of ARA-X Docking Station
- Do not short the ARA-X4 charging cable.
- Be sure nothing rests on the unit's cables or tubing. Ensure cables and tubing are not located where they can be stepped on, cut, tripped over, loosened, or disconnected.
- Do not place the unit on or near flammable materials.
- Do not immerse the power cable or plug in water.
- Do not drop the unit.
- Before cleaning the unit, disconnect the power supply from the power source.

Normal Operating Conditions

The ARA-X Docking Station is designed to be safe in the following conditions:

- Indoor use only
- Normal atmosphere (20.9% v/v O₂) that is free of hazardous gas
- Temperature range of +5°C to +40°C (+41°F to +104°F)
- Relative humidity of 10% to 90% non-condensing.

If the intended operating environment does not match these criteria, it is recommended that you consult a qualified professional before installing and using the ARA-X Docking Station.

Prepare the ARA-X Docking Station for test

Equipment Installation

Select a suitable installation location. Each module or group of connected modules requires:

- The ARA-X Docking Station to be placed on a clean, dry work surface.
- Access to a network or USB-PC connection
- Setting the test gas and concentration connected to Inlet#1 to #3 by 'ARA-X Manager'



WARNING: Do not use the stand if parts are missing or damaged.



WARNING: Do not attempt to repair or replace any parts of the stand. If the plate is damaged or missing, contact ION Science or an authorized distributor.



WARNING: The equipment must be used only in a normal atmosphere (20.9% v/v O₂) that is free of hazardous gas.



WARNING: Do not use the equipment in a hazardous area. Failure to adhere to this caution can lead to fire and/or explosion.



WARNING: Do not install near heat sources or on vibrating surfaces.
The equipment use only indoor.



WARNING: This equipment uses potentially harmful gas for calibrations. The equipment must be attached to a venting system or be used in a well-ventilated area.

Battery Charging

The ARA-X Docking Station is powered by External 12Vdc Adapter and internal rechargeable battery. Connect the supplied 12Vdc adapter to the DC Jacks on the ARA-X Docking Station to charge the battery. The docking station requires up to 4 hours charging to fully charge.

- Please use the DC power supply provided with your ARA-X Docking Station.
- The ARA-X Docking Station will not charge while bump tests or calibrations are being performed.
- If attempting to operate the device on battery power and the charge is insufficient, charge the battery for at least 30 minutes before performing the operation required on battery power. Once complete, then continue to charge the battery until full

Calibration Gas Installation

The ARA-X Docking Station requires a cylinder of the appropriate calibration gas connected to the ARA-X Docking Station in order to perform Bump and Calibration procedures. Connect the calibration gas cylinder to the ARA-X docking station as follows:

1. Connect the Exhaust outlet to ventilation. An external pump for ventilation is recommended.
2. Connect the Clean air supply to Purge Air inlet.
3. Connect the DFR to the test gas and verify the gas gauge shows the gas pressure
NOTE: DFR must be used for all test gases connected to inlet of the ARA-X Docking Station.
4. Connect the test gas with the Demand Flow Regulator (DFR) to each inlet as set in 'ARA-X Manager'.

NOTE: The gas types and concentrations must be equal to the setting of the ARA-X Docking Station.

The default configuration of gas concentrations is below:

GAS 1 INLET: Mix (H₂S-25ppm, CO-100ppm, O₂-18%, LEL(CH₄)-2.5%)

GAS 2 INLET: SO₂-10ppm

GAS 3 INLET: HCN-10ppm

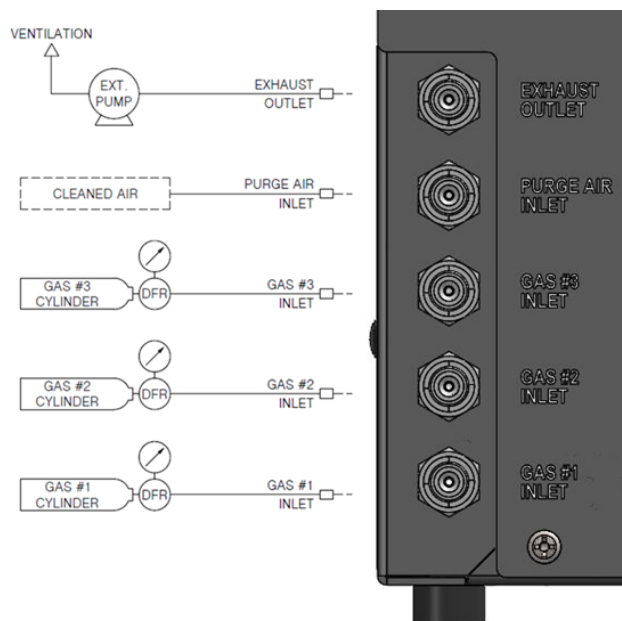

< Test Gas connection >



When connecting a gas, ensure to connect a fitting that matches with the hose connector.

If the tube coupling is damaged or missing, contact ION Science or your local authorized distributor to purchase replacements items.



Ensure the gas is certified, in good condition and that it has not expired.



This equipment uses potentially harmful gas for calibrations. You must attach the exhaust to a venting system or be used in a well-ventilated area.

Set Ventilation Flow Path

When operating the ARA-X Docking Station, it must be used in a normal environment (20.9% v/v O₂ and free of hazardous gas). If it is indoors and ventilation is difficult, the ARA-X Docking Station must be connected to Purge-Air and Exhaust to the outside air.

The procedure is below:

- 1) Connect the tube coupler to the Purge Air Inlet
- 2) Connect the tube coupler to the Exhaust Outlet
- 3) When disconnecting the tubes, press the metal cover on the side.



Ensure the tubing is a suitable length, not too long and is not blocked.



Ensure the exhaust tubing is not connected to a negative pressure system.

Operate the ARA-X Docking Station

Starting up the ARA-X Docking Station

Press the Power Button to turn on the ARA-X Docking Station. If the dock is DC powered, the Power LED will light up Blue. If the dock is battery powered, the Power LED will light up White.

Power LED	Status
OFF	Power Off
BLUE	Power On (12Vdc)
WHITE	Power On (Battery)
WHITE Blinking	Empty Battery

1. ARA-X Docking Station can be operated when the Power Button is lit up.
2. ARA-X Docking Station will automatically turn off, if it is idle for a long time. The default Auto Power-Off time is 5 minutes. Users can change this in the Docking Configuration page of ARA-X Manager PC software.
3. To power off the ARA-X Docking Station, press the Power button for at least 5 seconds. The progress LEDs will light up RED. Keep pressing the Power button until all progress LEDs are red and then release the button.
4. If the white LED blinks, the battery is low. Connect DC power for charging.

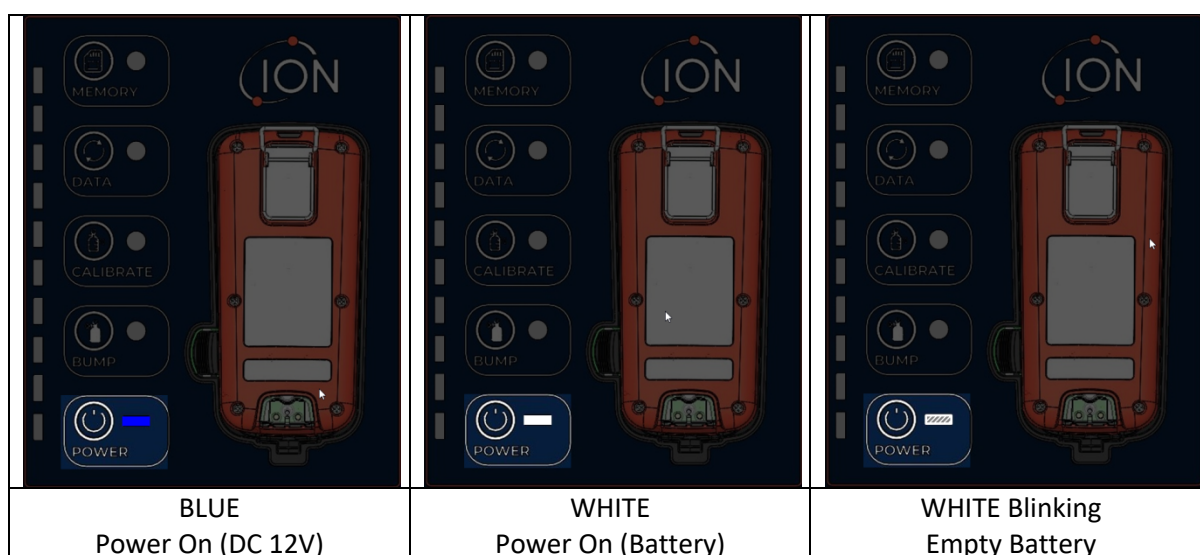

Test Overview

1. Insert the ARA-X4 securely to the Test Bay ensuring BOTH latches engage (two audible “clicks” should be heard).
2. Push the desired ARA-X Docking Station button (Bump, Cal or Data)

3. While the test or upload is active, the relevant button LED will blink and 10 display LEDs show progress to GREEN
4. When the test has completed, the LEDs will turn GREEN for pass or RED for fail.

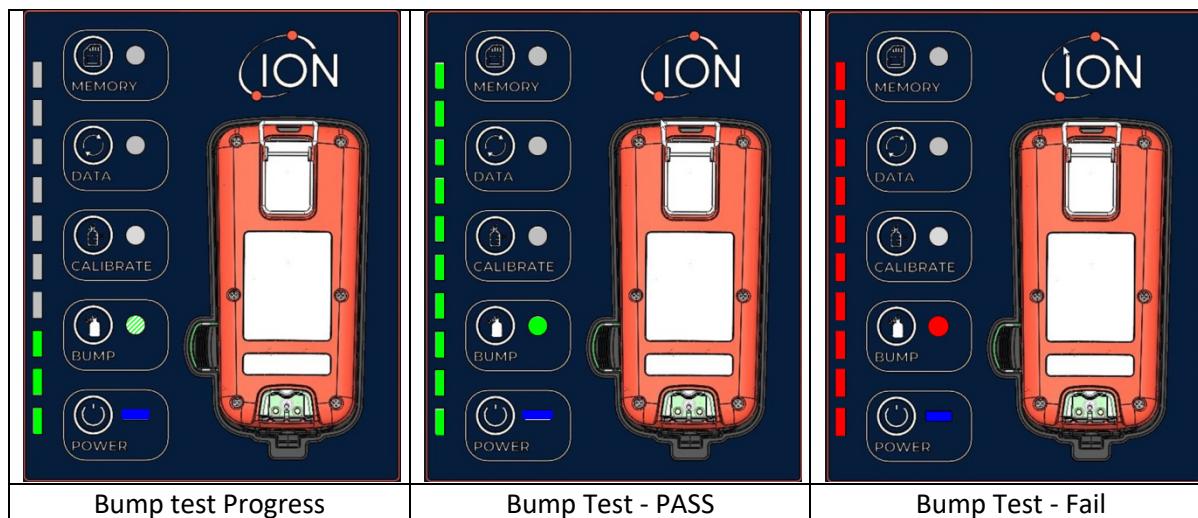

Please refer to the ARA-X Manager section of this manual for further guidance.



If gas detectors are not installed correctly, it may lead to gas leak and/or failure of tests.

Do not remove gas detectors until the test completes.

Bump Test

The Bump Test will check the ARA-X4 response to gas by injecting a small amount of gas; it will also check the LED, audio and vibrate alarms of the ARA-X4. This process takes approx. 30 seconds, as default. Bump test times can be adjusted via the ARA-X Manager PC software.

In ARA-X Manager it is possible to configure how a Bump test is initiated. Refer to the following scenarios:

- To bump test the inserted ARA-X4 when the 'Bump' button is manually pressed on the ARA-X Docking Station
- To automatically bump test an ARA-X4 when it is inserted in the ARA-X Docking Station
- To automatically calibrate an inserted ARA-X4 if it fails a bump test

Please ensure the ARA-X Docking Station is connected to the appropriate gas cylinders and these are all in good working condition. Failure to do so may trigger a Bump Fail error on the connected ARA-X4 device.

Once the bump test has been completed, a summary of the passed and failed tests will be shown on the ARA-X4 display. Press the Right button to acknowledge the result.

The Bump Log file will be saved and can be later downloaded via the Logs tab of the ARA-X Manager PC software.

Calibrate

The Calibrate button calibrates the ARA-X4 against the applied gas. This process takes up to 2 minutes. Calibration gas and concentrations can be configured via the Gas Cylinder page of ARA-X Docking Station tab in ARA-X Manager.

In ARA-X Manager it is possible to configure how a Calibration is initiated. Refer to the following scenarios:

- To calibrate the inserted ARA-X4 when the 'Calibrate' button is manually pressed on the ARA-X Docking Station
- To automatically calibrate an ARA-X4 when it is inserted in the ARA-X Docking Station
- To automatically calibrate an inserted ARA-X4 if it fails a bump test

Once the bump test has been completed, a summary of the passed and failed tests will be shown on the ARA-X4 display. Press the Right button to acknowledge the result.

The Calibration Log file will be saved and can be later downloaded via the Logs tab of the ARA-X Manager PC software.

Data

The 'Data' button can be configured via ARA-X Manager to initiate a variety of functions:

- Download data logs (Event, Bump, Cal, Data) to the ARA-X Docking Station
- Update the firmware of the connected ARA-X4 with a FW file pre-loaded into the ARA-X Docking Station by the Admin user.
- Upload a saved ARA-X4 configuration file which has been pre-loaded into the ARA-X Docking Station by the Admin user.
- Upload a saved ARA-X Docking Station configuration file which has been pre-loaded into the ARA-X Docking Station by the Admin user.
- To transfer data from the ARA-X Docking Station to the encrypted USB memory stick
- To transfer data from the encrypted USB memory stick to the ARA-X Docking Station
- To delete files from the ARA-X Manager, as configured by the user. Data is not deleted by default, and will need to be configured by the Admin user via ARA-X Manager PC software.

Press the 'Data' button to initiate the data transfer and any pre-configured tasks. The LEDs will indicate progress and success of the initiated actions.

If the 'Data' LED shows as amber, this indicates that part of the selected tasks were not completed successfully. A summary of the passed and failed tests will be shown on the ARA-X4 display. To check which tasks require further attention, remove the ARA-X4 from the ARA-X Docking Station to review these details. Press the Right button to acknowledge the result.

The Data Log files will be saved and can be later downloaded via the Logs tab of the ARA-X Manager PC software.

Memory

When pressed, the Memory button will indicate how much memory remains in the ARA-X Docking Station. The LEDs correlate to the memory space used; 1 LED illuminated being up to 10% full, and 10 LEDs illuminated being 100% full.

When all progress LED segments have been filled this indicates that the docking station memory is full and should be downloaded and deleted. This can be carried out via the 'Log' tab within ARA-X Manager.

Please refer to the 'ARA-X Manager' section of this manual for further details.

Equipment maintenance and service

Disconnect power and turn-off the ARA-X Docking Station before performing maintenance or cleaning.

To avoid personal injury or damage to the module, use only replacement parts and/or accessories obtained from ION Science or via an authorized distributor.



There are no user-serviceable parts inside the ARA-X Docking Station. Repair must be carried out by an ION Science authorized service centre only.



If the equipment is damaged or parts are missing, contact ION Science or your local authorized service centre immediately.



Substitution of components may impair the safety of the equipment.



Do not attempt to disassemble, adjust, or service the equipment unless instructions are provided to perform a procedure, or a component is listed as a user-replaceable component in the user manual.



Use only replacement components provided by ION Science.

Do not expose the equipment to electrical shock or severe and/or continuous mechanical shock.

To maintain the ARA-X Docking Station and ensure that it is in good operating condition, perform the following basic maintenance as required:

- To ensure quality product operation, maintain a log of all maintenance that is performed.
- Clean the exterior with a soft, damp cloth. Do not use solvents, soaps, or polishes.
- Adequate clearance for the power cord, cables and tubing.
- Adequate clearance for normal use, maintenance and cleaning.

ARA-X Manager PC Software

The ARA-X Manager application is used to connect to and maintain the ARA-X Docking Station and ARA-X4 devices.

The ARA-X Manager enables you to perform maintenance and configuration tasks on the ARA-X4 and docking station, to download data files, and update the firmware of ARA-X4 and ARA-X Docking Station. You can also upgrade the firmware of the docking station remotely using the provided USB memory stick when not directly connected to ARA-X Manager.

You can use these methods to connect the ARA-X4 to the PC on which ARA-X Manager is installed:

- Via the IR Link accessory
A USB cable connects the IR Link accessory to the PC. An infrared connection links the ARA-X4 to the IR Link accessory.
- With the ARA-X Docking Station
You place the ARA-X4 in the docking station, which is connected to the PC by a cable.

You can use the docking station without connecting it to the ARA-X Manager. Refer to the ARA-X Docking Station User Manual.

Download the ARA-X Manager software and latest firmware file from ionscience.com.

Overview

The ARA-X Manager has two top-level tabs: ARA-X Docking Station and ARA-X4. This manual focuses on the ARA-X Docking Station sections of the ARA-X Manager; please refer to the ARA-X4 user manual for more information on ARA-X4 functionality within ARA-X Manager.

The images and tables below describe the layout and purpose of the available fields.

In the tables, all options marked “Read only”, automatically reflect the settings on the connected ARA-X and cannot be updated. Options marked “User (Read only), Admin (Read/Write)” can be updated by an Admin user.

Connecting ARA-X4 to ARA-X Manager

When you first open the ARA-X Manager and ‘read’ your ARA-X4 or ARA-X Docking Station to the software, the software will prompt you to create and save a configuration file before you can make any configuration changes to your device. We recommend this is good practice to have a record of the primary configuration settings for your device.

To create an ARA-X4 config file, press the ‘ARA-X4 Config Save’ button to save your configuration file to your PC. To create an ARA-X Docking Station configuration, press the ‘Dock Config Save’ button. You can choose your preferred file name and location. You should create a configuration file for each model / sensor configuration that you have, and these should only be applied to the appropriate model.



You must create a configuration file before you can make changes to your ARA-X4 or ARA-X Docking Station. You should create a configuration file for each model you connect to ARA-X Manager.



Ensure that you press 'Read' each time you connect an ARA-X4 to the ARA-X Manager before writing settings.

ARA-X Docking Station

Device Configuration

In ARA-X Manager, click the ARA-X Docking Station tab.

1	Device connected	When connecting to ARA-X Manager, you must select your method of connection to the PC: COM: Device connected to serial port (ARA-X4 or ARA-X Docking Station). LAN: Device connected to LAN port (Docking Station only) USB Memory: USB memory stick inserted into PC.
2	Language	You can set the PC software to your preferred language. Choose from: English, German, French, Spanish, Italian, Portuguese, Chinese, Dutch
3	Dock configuration	Serial Number: Dock Serial Number (Read only). FW (firmware) version: Dock FW version (Read only).

		<p>HW (hardware) version: Dock HW version (Read only).</p> <p>Dock User ID: To assign an ID to the ARA-X Docking Station User (Read only), Admin (Read/Write).</p> <p>Dock Location: To assign where the dock is located. User (Read only), Admin (Read/Write).</p> <p>Auto Power-Off Time: The user can configure the docking station to power down after a period of time of inactivity by the user. This is set in minutes. User (Read only), Admin (Read/Write).</p> <p>Bump Test Speed: Users can select to carry out a Quick Bump or Full Bump Test. Bump times can be modified via the Dock Configuration page. User (Read only), Admin (Read/Write).</p> <p>Time/Date: Time and date on the ARA-X Docking Station.</p> <p>Set Time/Date to PC: To synchronize the time & date on your ARA-X Docking Station with the PC software, tick the checkbox next to this option and press the smaller 'write' button next to the time & date. Then, when you have updated any other required setting adjustments, please the 'write' (15) button</p> <p>Quick Bump max time: The maximum time that the dock will try to carry out a quick bump test on the installed ARA-X4 before it triggers a pass or fail result. Users can select between 10 to 60 sec.</p> <p>Full Bump max time: The maximum time that the dock will try to carry out a full bump test on the installed ARA-X4 before it triggers a pass or fail result. Users can select between 10 to 120 sec.</p> <p>Quick Bump pass limit: The percentage of the full calibration point concentration the device must read to achieve in a quick bump pass result. Users can select between 50 to 80%. Default is set to 50%.</p> <p>Full Bump pass limit: The percentage of the full calibration point concentration the device must read to achieve in a full bump pass result. Users can select between 80 to 100%. Default is set to 80%.</p>
4	<p>Dock configuration (Admin Mode)</p>	<p>Allow visual test: If selected, the ARA-X Docking Station will complete a visual test on ARA-X4 once it has been fitted into the dock, to check the LEDs are working correctly.</p> <p>Allow audible test: If selected, the ARA-X Docking Station will complete an audio test on ARA-X4 once it has been fitted into the dock, to check the sounder is working correctly.</p> <p>Allow LEL different: The user can select an LEL gas that is different from the LEL gas used to calibrate the ARA-X4</p> <p>Download ARA-X4 data logs: datalogs can be downloaded manually by pressing the 'Data' button, or automatically when inserted into the dock.</p> <p>Calibration After Bump Failed: Auto calibrates the ARA-X4 if bump test fails. Users can switch this function on or off.</p> <p>ARA-X4 Bump Test: a bump test can be initiated manually by pressing the 'Bump' button, or automatically when inserted into the dock.</p> <p>ARA-X4 Firmware update: firmware can be manually updated by pressing the 'Data' button, automatically upgraded when ARA-X4 is inserted into the dock, or this functionality can be disabled.</p> <p>Admin users can select which firmware file to upload to the ARA-X Docking Station using the folder icon. Then, press the small 'write' box to install this onto the ARA-X Docking Station.</p> <p>Press the 'delete' button to remove the current ARA-X4 firmware version that the dock is configured with.</p> <p>Transfer ARA-X4 data to/from USB drive: the ARA-X Docking Station can be set to automatically transfer data to/from a connected USB drive when</p>

		<p>inserted, or to manually transfer data when the 'Data' button is pressed. Admin users also have the option to delete data after it has been transferred.</p> <p>ARA-X4 Calibration: a calibration can be initiated manually by pressing the 'Calibrate' button, or automatically when inserted into the dock.</p> <p>ARA-X4 Configuration Update: an ARA-X4 configuration file can be initiated manually by pressing the 'Data' button, or automatically when inserted into the dock.</p> <p>Admin users can select which configuration file to upload to the ARA-X Docking Station using the folder icon.</p> <p>Admin users can switch this function on or off and delete a configuration file from the Dock using the Delete option.</p>
5	Dock FW (Firmware) (Admin)	Icon to load Dock firmware upgrade file from PC. You can choose which upgrade file to use.
6	Dock FW Upgrade (Admin)	Button to start the firmware upgrade.
7	Dock Config (Admin)	Icon to load Dock configuration file from a saved location. Configurations can be saved and then be used to configure multiple devices.
8	Dock Config Save (Admin)	Button to save a Dock configuration file to a location
9	Read	<p>Button to read config file and log file from the ARA-X4 Device, ARA-X Docking Station or USB memory folder.</p> <p>If an ARA-X4 device is installed within the ARA-X Docking Station, the ARA-X4 details will be read into the ARA-X4 tab. If no ARA-X4 device is installed within the ARA-X Docking Station, only the details from the ARA-X Docking Station will be read.</p>
10	Write	Button to write the config file and firmware to the device.
11	Message Bar	<p>Displays the status as text when interacting with ARA-X Manager button options.</p> <p>Error messages are displayed as appropriate.</p>
12	Progress Bar	The green progress bar indicates the results of actions and communication progress, such as connecting to ARA-X Manager or downloading data.

Creating a Device Configuration File

It is possible to create a default configuration file which can be easily applied to different devices.

The configuration settings that can be adjusted include:

- Alarm settings
- STEL / TWA method
- Bump & Calibration intervals
- ARA-X4 device configuration preferences, such as language, datalogging type, quick access buttons
- ARA-X Docking Station preferences, such as automatic features, bump and calibration limits

There are three ways to create a configuration file:

1. **ARA-X4 config only:** Connect an ARA-X4 via ARA-X Docking Station or IR Link, make adjustments to the ARA-X4 configuration and save this for future use.
2. **ARA-X Docking Station config only:** Connect an ARA-X Docking Station, make adjustments to the ARA-X Docking Station configuration and save this for future use.
3. **ARA-X4 or ARA-X Docking Station config file:** Configure the settings within ARA-X Manager without an ARA-X4 or ARA-X Docking Station connected and save this file for future use.

ARA-X4 Configuration file:

Open the ARA-X Manager and navigate to the ARA-X4 tab. Make the desired changes to the Device Configuration. Press the 'ARA-X4 Config Save' button and choose the location and name for your configuration file.

ARA-X Docking Station Configuration file:

Open the ARA-X Manager and navigate to the ARA-X Docking Station tab. Make the desired changes to the Dock Configuration. Press the 'Save' button and choose the location and name for your configuration file.



A configuration file must be created for each model type. Only configuration files for matching sensor configurations should be used. Please check this before applying to ARA-X4.

Loading a saved Configuration File

ARA-X4 Configuration file:

There are two options for sending a saved configuration file to your ARA-X4:

1. Send to an ARA-X4 which is connected to ARA-X Manager by ARA-X Docking Station or IR Link. Please refer to the ARA-X4 user manual.
2. Install the default configuration file within your ARA-X Docking Station, which can be applied to every compatible ARA-X4 that is connected to your ARA-X Docking Station.

To load an ARA-X4 configuration file onto your ARA-X Docking Station, please follow the steps below:

1. Open the ARA-X Manager and connect to the ARA-X Docking Station
2. Navigate to the Dock Configuration tab page within the ARA-X Docking Station tab.
3. In the 'ARA-X Cfg Update' section, select the designed configuration file and choose from the 3 options:
 - a. Automatically on insertion: the ARA-X4 configuration file will be uploaded to the connected ARA-X4 once inserted into the ARA-X Docking Station
 - b. Manually on button press: the ARA-X4 configuration file will be uploaded to the connected ARA-X4 once the 'Data' button is pressed.

- c. Do not update: the configuration file will not be applied to the connected ARA-X4 device either on insertion to the docking station or by manually pressing the 'Data' button.

NOTE: to successfully apply a configuration file, the ARA-X4 must have the same sensors installed to match the saved configuration. If the sensors do not match, an error message will appear, and the configuration will not be applied to the device.

ARA-X Docking Station Configuration file:

To load an ARA-X Docking Station configuration file onto your ARA-X Docking Station, please follow the steps below:

1. Open the ARA-X Manager and connect to the ARA-X Docking Station
2. Navigate to the Dock Configuration tab page within the ARA-X Docking Station tab.
3. In the 'Dock Config.' Section, select the folder icon to choose the desired configuration file.
4. 'Write' the Dock Config. File to your ARA-X Docking Station.

To load a configuration file to the ARA-X Docking Station via USB:

1. Insert your encrypted USB to your PC or laptop.
2. Locate your desired configuration file (ARA-X4 or ARA-X Docking Station) and copy this to the encrypted USB.
3. Eject the USB from your PC or laptop.
4. Locate your ARA-X Docking Station and insert the encrypted USB to the correct USB connector.
5. Press the 'Data' button.



A configuration file must be created for each model type. Only configuration files for matching sensor configurations should be used. Please check this before applying to ARA-X4.



You must apply a configuration file for both the ARA-X4 and ARA-X Docking Station before sending to the ARA-X Docking Station.

Gas Cylinder Settings

On the Gas Cylinder tab, an Admin user can add these details of the gas cylinder used:

- Serial number
- Expiration data
- Gas type
- Gas concentration

Standard users have read-only access to the information. Select 'write' to apply settings to the device.

ARA-X Manager Admin V1.1.11

ARA-X Docking Station ARA-X4 Logs SW Configuration Admin

Gas Cylinder

Device Connected
 COM
 LAN
 USBMemory

Language
 English

ION Science LTD.
 The Hive, Butts Lane, Fowlmere
 Royston, SG8 7SL, UK
 Tel: +44 (0) 1763 208 503
 info@ionscience.com

Dock Configuration

Gas Input#1

Expiration Date	2024.8.12	H2S	25.0	ppm
Gas Lot No	Lot250203	CO	100.0	ppm
		O2	18.0	%
		Methane	50.0	%LEL
			0.0	

Gas Input#2

Expiration Date	2025.12.1		0.0	
Gas Lot No	Lot26801		0.0	
			0.0	
			0.0	
			0.0	

Gas Input#3

Expiration Date	2025.8.5		0.0	
Gas Lot No	Lot03234		0.0	
			0.0	
			0.0	
			0.0	

Read Logs Read All Write

OK

Logs

The screenshot shows the ARA-X Manager Admin V1.1.14 interface. The main window displays the 'Logs' section for a connected ARA-X4 device. A table lists log sessions with columns for Session, File Name, Button, and Size. The 'Logs Read All' button is highlighted with a red box and the number 3. The right-hand panel contains 'Log Select and Read' options, including radio buttons for Event Log, Bump Log, Calibration Log, and Datalog (selected). Below these are buttons for Datalog Stop (5), Datalog Start (6), Log Read (7), and Clear ARA-X4 Logs (8). A 'Log From Local Disk' button (4) is also present. The 'Conversion' section has radio buttons for Excel (9) and ARA-X Manager View. A 'Delete' button (10) is at the bottom right. The 'Serial Number' field (1) shows 'BB25140006' and the 'User ID' field is empty. The 'Session' table (2) lists 13 sessions with file names and 'View' buttons. The 'Language' dropdown is set to 'English'. The ION Science LTD. contact information is visible in the bottom left.

Admin Mode

1	Log summary	The logs are shown by serial number of connected ARA-X4 device, and user ID
2	Session	Displays the downloaded log files that are available on the ARA-X4 device. Logs are shown by log type (bump log, cal log, data log, event log), serial number, date and session number. Use the 'Excel' and 'ARA-X Manager View' buttons (4) to choose whether you want to view the logs in ARA-X Manager, or export to Excel. Then, press the 'View' button to open the logs in the desired format. Data logs are stored in the following location, as default: C:\ION Science LTD\Ara-X Manager\ION Science\ARAX\Logs
3	Log Read All	To read all logs from the ARA-X4 device at once
4	Log from local disk	To open previously downloaded log files via the ARA-X Manager
5	Stop data log	To stop data logging on the connected ARA-X4 device
6	Start data log	To start data logging on the connected ARA-X4 device
7	Log Read	To download only a specific type of log file, use the radio buttons to select the log type of interest and then press the 'Log read' button. Log type options are: Event Log, Bump Log, Cal Log, Data Log

8	Clear ARA-X4 logs	Clears the logs from the ARA-X4 device memory
9	Log view / log conversion	Use the radio button to choose whether you want to view the logs in ARA-X Manager, or export to Excel. Then, press the 'View' button to open the logs in the desired format.
10	Delete	To delete the selected log from ARA-X Manager. First, highlight the log that you wish to delete, then press the 'delete' button.

SW Configuration

The ARA-X Docking Station can be configured to work on a local network. You can connect to ARA-X Manager via the LAN connection setting and configure your Ethernet settings via this page when logged into ARA-X Manager Admin Mode:

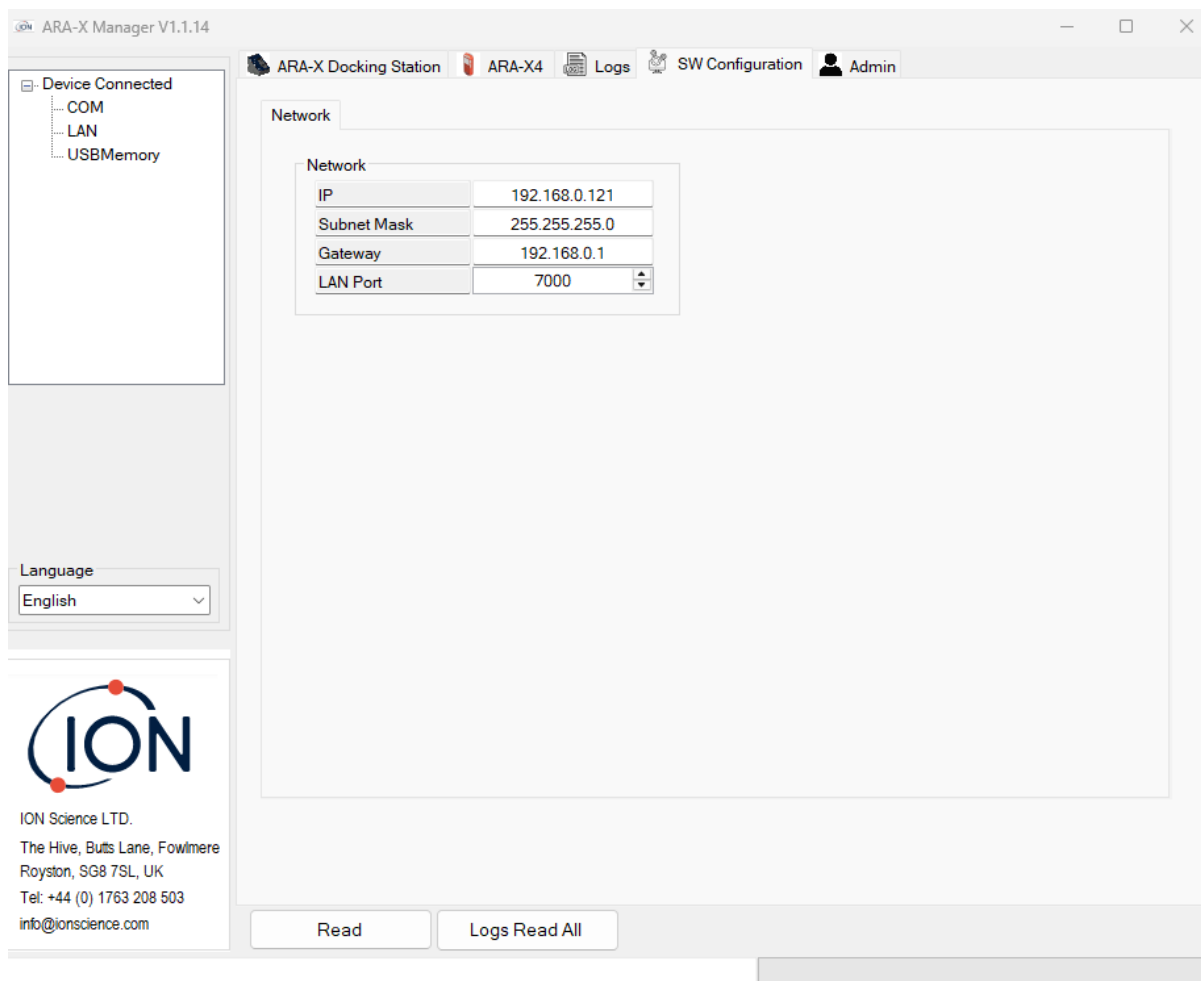

ARA-X Manager V1.1.14

ARA-X Docking Station ARA-X4 Logs SW Configuration Admin

Device Connected
 ...COM
 ...LAN
 ...USBMemory

Language
 English

ION Science LTD.
 The Hive, Butts Lane, Fowimere
 Royston, SG8 7SL, UK
 Tel: +44 (0) 1763 208 503
 info@ionscience.com

Network

IP	192.168.0.121
Subnet Mask	255.255.255.0
Gateway	192.168.0.1
LAN Port	7000

Read Logs Read All

Admin Login

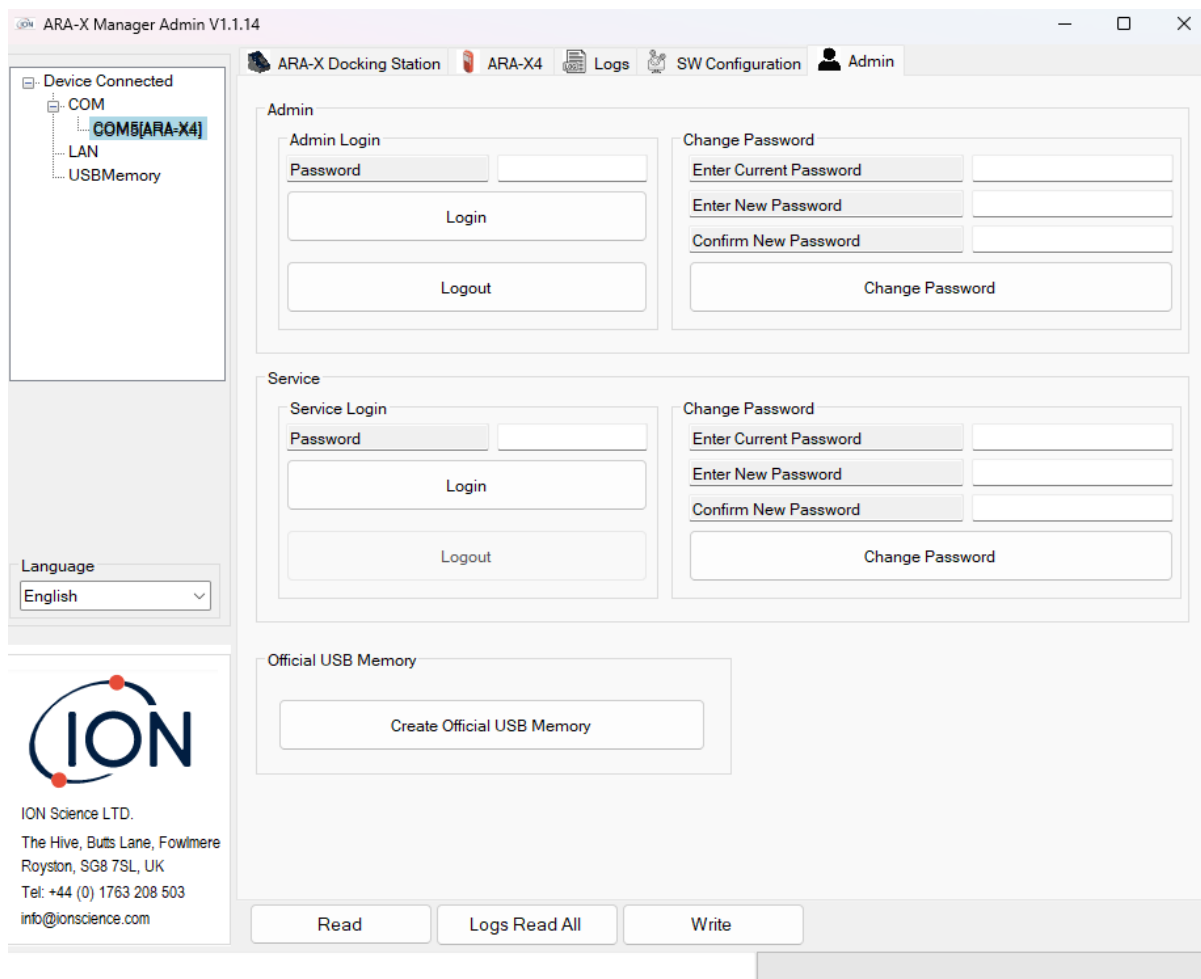

Admin Login: Enter your password and log in to use ARA-X Manager in administrator mode. The default password is "2025".

Admin Logout: Press this option to revert ARA-X Manager to standard User Mode.

Change Password: An Admin user can change passwords by entering a current password and a new password.

Service Password: For use by ION Science service trained personnel only.

Create Official USB Memory: To generate an encryption key code to configure your USB memory for use with the ARA-X Docking Station.

Creating an encrypted USB

To transfer data between ARA-X Docking Station and ARA-X Manager it is necessary to use an encrypted USB. The ARA-X Docking Station is supplied with a USB, however, it is possible to encrypt a standard USB to be used with the ARA-X Manager and ARA-X Docking Station.

To create an encrypted USB, this can be done in Admin mode of ARA-X Manager:

1. Insert your USB into your PC

2. Open ARA-X Manager and select the 'USB Memory' option from the 'Device Connected' option.
3. Press 'Read'
4. Navigate to the Admin tab and enter your Admin password. The 'Create Official USB Memory' option should now appear.
5. Press 'write'

You can now transfer data between ARA-X Manager and your ARA-X Docking Station.

To transfer data to the encrypted USB, this must be done via the ARA-X Manager. To do so, load the desired settings or configuration settings into ARA-X Manager and press the 'write' button, whilst the encrypted USB is connected.



The ARA-X Docking Station will not accept files that have been manually transferred onto the USB from the PC, and these must be uploaded to the USB via the ARA-X Manager.

Technical Specification

Dimension (WxHxD)	188 x 185 x200 mm
Weight	2.4 kg
Operating temperature	5°C to 40°C (+41°F to +104°F)
Humidity	10% to 90% non-condensing
Altitude	1,000m (3,280.84ft)
Storage temperature	-10°C to 60°C (+14°F to +140°F)
Power supply	Supply Voltage: - Input: 100-240V AC, 50/60Hz Max 0.5A - Output: 12 V DC, 1.5A Power Rating: - 12 V DC, 1.5A (Adapter) - 7.4V DC, 2,750mAh (Internal Battery)
Time & Date	Provides time and date stamp
Data Storage	Internal data storage plus External USB 2.0 Memory Stick (32GB)
External Interface	1 USB port - USB 2.0 1 RJ45 - Ethernet 10/100
Display	4 Functional and 10 Indication LEDs - LEDs are R/G 2 colors Power LED – Blue/White - Blue: externally powered, White: battery powered,
Compatible devices	ARA-X4
Test unit recognition	IrDA communication
Tests	Bump, Calibration, Data Transfer, Audible alarm, Visual Alarm, Memory Space Remaining
Gases Available	H2S - 25ppm, CO - 100ppm, O2 - 18%, SO2 - 10ppm LEL-CH4 2.5%, HCN - 10ppm
Gas connection	5 Tube coupler – Hose Barb 1/8" - 1 Exhaust outlet - 1 Purge Air inlet - 3 Test gas connection
Pump	2 pumps (built-in), 150 – 600 mL per minute
Battery	Lithium-Ion Battery Pack, 7.4V, 2,750mAh, 20.08Wh
Battery Charging time	Up to 4 hours
Battery Run time	5.5 hours
Warranty	1 year as standard*

*2 years extended warranty available when registered via the ION Science website

Troubleshooting

Question	Answer
The ARA-X Docking Station does not power-on	1) Connect the power adapter. 2) Try switching on the ARA-X Docking Station whilst connected to power supply. Observe whether the LED lights register. If no response to power and switch on is observed, please contact your local service centre.
The detector fails a bump test.	To troubleshoot a calibration or bump test failing, check the following: <ul style="list-style-type: none"> - Using the correct gas that ARA-X4 specifies - Ensure the inlets are hooked up properly and the tubing does not have any kinks - Ensure the gas cylinder has an adequate amount of gas - Ensure the ARA-X4 is placed correctly in the Test Bay - Ensure the ARA-X Docking Station has an adequate power source - Ensure the ARA-X Docking Station is on a stationary surface. Do not place ARA-X Docking Station on vibrating equipment If the above items have been checked, try calibrating your device and bump testing again. Check the ARA-X4 display screen and the Bump & Cal logs for any errors. If problems persist, contact ION Science or your local distributor.
The calibration gas tube coupler is broken or missing	Please contact ION Science or your local distributor to purchase replacement parts.
Updating the calibration gas type or concentration / incompatible bump or cal	The ARA-X Manager software should be used to set the test gases connected to Inlet #1 to #3. If the set test gas does not match the sensor on the ARA-X4, the test will not proceed.
Gas usage	ARA-X Docking Station's flow rate is near 400 ml/min. A bump test's gas application lasts for 30 seconds, equating to 200ml of gas usage. A calibration's gas application lasts for around 2 minutes, equating to around 800ml of gas usage.
Gas cylinder empty	When your regulator shows below 100psi, it is time to replace your gas cylinder. Your bump test and calibration may fail due to your cylinder not having adequate gas.
The audible alarm test fails	Clean the ARA-X4 and ARA-X Docking Station's audible cavity. If you notice debris in audible cavity, do not disassemble the device. Please contact ION Science or your local service centre.
Visual alarm test fails	1) Wipe clean the ARA-X4's LED windows 2) Wipe clean the visual alarm hole in Test Bay

Limited Warranty

ION Science warrants the product to be free from defects in material and workmanship under normal use and service for a period of two years, beginning on the date of shipment to the buyer. This warranty extends only to the sale of new and unused products to the original buyer.

This warranty does not include:

- Any damage or defects attributable to repair of the product by any person other than an authorized dealer, or the installation of unapproved parts on the product; or
- Any product which in ION Science's opinion, has been misused, altered, neglected or damaged, by accident or abnormal conditions of operation, handling or use.

The obligations set forth in this warranty are conditional on:

- proper storage, installation, calibration, use, maintenance and compliance with the product manual instructions and any other applicable recommendations of ION Science.;
- The buyer promptly notifying ION Science of any defect and, if required, promptly making the product available for correction. No goods shall be returned to ION Science. until receipt by the buyer of shipping instructions from ION Science; and
- The right of ION Science to require that the buyer provide proof of purchase such as the original invoice, bill of sale or packing slip to establish that the product is within the warranty period.

Please refer to the ARA-X4 warranty statement for full details.

Certifications / Approvals:

CE

ION Science Contact Details

ION Science Ltd – UK/Head Office

Tel : +44 (0) 1763 208 503

Web: www.ionscience.com | Email: info@ionscience.com

ISM ION Science Messtechnik – Germany Office

Tel: +49 (0) 2104 1448-0

Web: <https://www.ism-d.de/en/> | Email: sales@ism-d.de

ION Science India – India Office

Tel: +91 4048536129

Web: www.ionscience.com/in | Email: kschhari@ionscience.com

ION Science Inc – USA Office

Tel: +1 877 864 7710

Web: <https://ionscience.com/usa/> | Email: info@ionscienceusa.com

ION Science Italy – Italy Office

Tel +39 051 0561850

Web: www.ionscience.com/it | Email: info@ionscience.it

ION Science France – France Office

Tel: +33 613 505 535

Web: www.ionscience.com/fr | Email: info@ionscience.fr

ION Science China – China Office

Tel: +86 21 52545988

Web: www.ionscience.com/cn | Email: info@ionscience.cn

Revision

Date	Revision	Changes
15/05/2025	V1.0	Original user manual
26/08/2025	V1.1	Updates to ARA-X Manager functionality and descriptions, additional clarity regarding docking station use.
23/01/2026	V1.2	Ethernet functionality added and updated ARA-X Manager images.