



TVOC 2

Instrument User Manual V1.3



Register
your instrument
online to receive your
extended Warranty.

Register your instrument online for an extended warranty

Thank you for purchasing your Ion Science instrument.

The standard warranty of your instrument can be extended to two years.

To receive your extended warranty, you must register your instrument online within one month of purchase (terms and conditions apply).

Click [here](#) to extend your instrument warranty, or scan the QR code below.





Content

Safety	5
Legal Notices Regarding the Safe Operation of Equipment	5
Symbols	5
Warnings, Cautions and Information Notifications	6
Disposal	7
Certifications	7
Statements	7
Responsibility for Use.....	7
Warnings	8
Disposal	8
Legal Notice.....	8
Calibrating with Alternative Gases	9
Introduction to TVOC 2	11
Packing List	11
Standard TVOC 2 Instrument	11
TVOC 2 Set-up	12
Selector Pins.....	12
Installation	13
Location.....	13
Cable and Gland Requirements.....	13
Dimensions for Mounting	15
Power Requirements.....	15
Initial Calibration	18
Operation	18
Start-up	18
LED Statuses.....	19
Selector Pins.....	19
Calibration Mode	19
Calibration Gases.....	20
Calibration Routine	20
Setting the ZERO	21
Setting Span Gas Concentration.....	21



Setting the SPAN 22

Calibration 22

Bump Test 23

Maintenance 23

 Cleaning the MiniPID 2..... 23

 To Clean the PID Lamp 25

 Reassembly 25

 Use of PID Lamp Cleaning Kit A-31063 26

 Fuse Rupture and Replacement 27

System Recommendations 27

 Gas Sample Systems 28

 Flow Adapter Fitting Instructions 28

Quality Assurance 29

Warranty 29

 Instrument 29

 Lamp..... 29

Service 29

Diagnostics 30

 F1 Error..... 30

 F3 Error..... 31

 F4 Error..... 31

Spare Parts and Accessories 32

 TVOC 2 Tool Kit (A-849214)..... 32

 Spare List 32

Technical Specifications 33

 Zone 1 or Zone 2 Intrinsic Safe Installation 33

 Zone 2 Installation..... 34

Manual Log 35

ION Science Contact Details 36

Safety

Legal Notices Regarding the Safe Operation of Equipment

- Whilst every attempt is made to ensure the accuracy of the information contained in this manual, ION Science Limited accepts no liability for errors or omissions in the manual, or any consequences deriving from the use of information contained herein. It is provided “as is” and without any representation, term, condition or warranty of any kind, either expressed or implied.
- To the extent permitted by law, ION Science shall not be liable to any person or entity for any loss or damage which may arise from the use of this manual.
- We reserve the right at any time and without any notice to remove, amend or vary any of the content which appears in this manual.

Symbols



WARNING!

USED TO INDICATE DANGER WARNINGS WHERE THERE IS A RISK OF INJURY OR DEATH.



Caution

Used to indicate a caution where there is a risk of damage to equipment.



Information

Important information or helpful hints about usage.



Recycling

Recycle all packaging.



WEEE Regulations

Ensure that waste electrical equipment is disposed of correctly.

Warnings, Cautions and Information Notifications

The following Cautions apply to the product described in this manual.



Inadequate performance of the gas detection equipment described in this manual may not necessarily be self-evident and consequently, the equipment must be regularly inspected and maintained.



ION Science recommends that personnel responsible for equipment use institute a regime of regular checks to ensure it performs within calibration limits, and that a record be maintained which logs calibration check data.



The equipment should be used in accordance with the safety standards and installation instructions given in this manual, and in compliance with local safety standards.



Protect the PID sensor from exposure to silicone vapours, as this may foul the lamp windows and reduce the response to some gases. This can usually be remedied by polishing the lamp window with alumina powder.



Do not use abrasive or chemical detergents to clean the TVOC 2 instrument, as this may reduce the antistatic properties of the materials used; clean it only with a damp cloth.



The TVOC 2 must not be exposed to atmospheres known to hurt Thermoplastic Elastomers or Polycarbonate.



Outside the items covered in this manual, they must be serviced in a Non-Hazardous environment and by ION Science authorised service centres only. Substitution of components may impair intrinsic safety.



Ingress Protection: Continuous exposure to wet weather conditions should be limited to less than one day and harsh water spray conditions should be avoided.



Proper Use: If the equipment is used in a manner not specified by the manufacturer, its protection may be impaired.

The following Warnings, Cautions, and Information notifications appear later in this manual where applicable.



IF AN ALARM STATE IS TRIGGERED, THE USER SHOULD LEAVE THE HAZARDOUS ENVIRONMENT AND ACT IN ACCORDANCE WITH NATIONAL SAFETY REGULATIONS.



THE CLEANING COMPOUND CONTAINS ALUMINIUM OXIDE AS A VERY FINE POWDER. THIS MAY CAUSE IRRITATION OF THE RESPIRATORY TRACT AND EYES. (CAS Number 1344-28-1).



Internal components must be handled with clean hands and clean tools. The lamp is fragile. Handle with great care. Never touch the window and do not drop.



Never refit a damaged Lamp.



The instrument **MUST** be recalibrated after fitting a replacement or cleaned Lamp.



The TVOC 2 has been designed for use in Zone 2 hazardous areas without safety barriers, whilst its ATEX and IECEx approvals allow it to be used in Zone 1 hazardous areas with safety barriers.



Important note: Always check the calibration during regular operation before use by performing a bump test. Apply the same Zero and SPAN gas used to calibrate and ensure the correct readings are displayed.

Disposal

- The equipment does not include any toxic materials, but if toxic materials have contaminated it, then exercise due care and follow the appropriate regulations when disposing.
- Always adhere to local regulations and procedures when disposing of the equipment.
- Ion Science offers a take-back service. Please contact ION Science for more information.



RECYCLING
Recycle all Packing.



WEEE REGULATIONS
Ensure that all waste electrical equipment is disposed of correctly.

Certifications

- IECEx Certificate – IECEx BAS 06.0057X
- ATEX Certificate - Baseefa05ATEX0277X
- UKEX Certificate - BAS21UKEX0574X

Statements

Responsibility for Use

TVOC 2 detects volatile organic compounds (VOCs) that may present toxic and explosive hazards. The detector offers selectable configurations for various applications. Users are responsible for the correct configuration and appropriate response to all readings. ION Science Ltd accepts no responsibility for harm or damage resulting from incorrect adjustment, configuration, or misuse.

Gas detection equipment may fail or drift out of calibration without showing obvious signs. Regular inspection and maintenance are essential. ION Science recommends that responsible personnel establish a routine inspection schedule to verify that the equipment operates within calibration limits. Maintain detailed records

of all calibration checks and test results. Always use this equipment in accordance with this manual and applicable local safety standards.

Warnings

1. Substitution of components may impair intrinsic safety and result in unsafe conditions.
2. For reasons of safety, TVOC 2 must only be operated and serviced by qualified personnel.
3. Please read and understand this user manual thoroughly before installing, operating or servicing TVOC 2.
4. In the event of the internal supply fuse being ruptured, the 4-20 mA output will not indicate a system failure. Therefore, we advise that the TVOC 2 installation be inspected regularly.

Disposal

Dispose of TVOC 2 and its components in accordance with all local and national safety and environmental requirements. This includes the European WEEE (Waste Electrical and Electronic Equipment) directive. ION Science offers a take-back service. Please contact us for more information.

Legal Notice

Whilst every attempt is made to ensure the accuracy of the information contained in this manual, Ion Science accepts no liability for errors or omissions, or any consequences deriving from the use of information contained herein. It is provided "as is" and without any representation, term, condition or warranty of any kind, either expressed or implied. To the extent permitted by law, ION Science shall not be liable to any person or entity for any loss or damage which may arise from the use of this manual. We reserve the right at any time and without any notice to remove, amend or vary any of the content which appears herein.

TVOC 2 is a fixed, continuous monitor for the detection and measurement of total volatile organic compounds, which can be dangerous from both poisoning and explosive perspectives. Total VOCs are detected using PID (Photoionisation detection) technology.

TVOC 2 has a number of user-selectable features that define its operation and will be application-dependent. The user can specify the detection range as 0.01 – 10 ppm, 0.1 – 100 ppm, or 1 – 1,000 ppm (Default), and the detection units as ppm or mg/m³.

NOTE: TVOC 2 can be calibrated with alternative gases to Isobutylene; however, to ensure it remains within specification, the correct concentration of the alternative gas must be selected.

Example: Benzene gas has a response factor of 0.5, which means only half as much concentration is required to produce the equivalent of Isobutylene.

The ideal gas/concentrations used to set the calibration SPAN are shown below:

Range	Lower limit	Upper limit	Equivalent Gas
10 ppm	8 ppm	12 ppm	Isobutylene equivalent
100 ppm	90 ppm	110 ppm	Isobutylene equivalent
1,000 ppm	900 ppm	1100 ppm	Isobutylene equivalent

Calibrating with Alternative Gases

Concentration calculations for gases other than Isobutylene:

Calibration Gas	Ideal response (Isobutylene)		Response factor		Ideal calibration gas concentration
Benzene	100	X	0.5	=	50 ppm
Isoprene	100	X	0.9	=	90 ppm
Isobutylene	100	X	1.0	=	100 ppm
Carbon disulfide	100	X	1.4	=	140 ppm
Ethyl acrylate	100	X	2.3	=	230 ppm

For other gas response factors, please refer to the ION Science website or contact ION Science.

<https://www.ionscience.com/product-range/search-by-gas/>

WARNING: Ignoring these guidelines may result in calibration failure, loss of resolution or loss of range.

The default settings of TVOC 2 are:

Detection range: 1 – 1000 ppm

Units: ppm

TVOC 2 provides a continuous 4-20 mA output that can be integrated into industrial control systems, building management systems, or data acquisition equipment to indicate VOC levels in the operating environment.

NOTE: External power (8-35 V DC) is required for the 4-20 mA output.

In addition to the 4-20 mA output, the TVOC 2 has an LCD showing gas concentration and four colour LEDs. The basic LED functions are as follows:

LED Colour	LED Name	Status Description	Action Required
● Green	Status	Normal working status	Normal - No action
● Red	Fault	fault indicator	URGENT attention required
● Yellow	Calibration	calibration status indicators	Review calibration

Please see the



LED Statuses Section for more information on LED status.

Introduction to TVOC 2

For installation requirements, please refer to the Installation and Technical Specification of this manual. Before attempting an installation, please fully read and understand this user manual. For hazardous area installations, refer to the TVOC 2 Intrinsically safe certificate for further details.

The TVOC 2 safety rating permits its deployment in all hazardous areas of the quoted rating (or lower). For details, refer to the marking on your instrument (found on the front main label). Units are manufactured with two protection concepts, each certified separately:

1. Intrinsic safety (ia):
 - ia permits the deployment in areas where explosive gases (of group IIA, IIB and IIC) are intermittently present (Zone 1) with an ambient temperature range of -20 to +50 °C. Intrinsically Safe installations will require the use of safety barriers and appropriate wiring.
2. Non-sparking (nA):

nA permits deployment in areas where explosive gases (of group IIA, IIB, IIC) are unlikely, but possible (Zone 2) with an ambient temp range of -40 °C to +50 °C. Non-sparking installations do not require safety barriers; however, the maximum working voltage must be strictly adhered to for safety. As no safety barriers are required, there is complete flexibility in implementing a three-wire system.

TVOC 2 does require regular calibration on site; see the Calibration Mode for more information.

Packing List

All equipment shipped by ION Science is packed in suitable containers and filled with a shock-absorbing material that provides a high degree of protection against physical damage.

Contents should be carefully removed and checked against the packing list. Any discrepancies between the contents and the packing list must be reported to ION Science within ten days of receipt of shipment. ION Science cannot be held responsible for shortages not reported within the period.

Standard TVOC 2 Instrument

Item	Description	Qty
1	TVOC 2 instrument	1
2	Cable gland M20 (Ex Certified)	2
3	Blanking plug M20 intrinsically (Ex Certified)	1
4	TVOC 2 Safety Notices	1
5	TVOC 2 Basic Lamp Cleaning Kit (A-900215)	1

TVOC 2 Set-up

Selector Pins

TVOC 2 has several settings that the user can select via a row of four selector pins mounted on the reverse side of the main PCB. Figure 1 shows the location of the functional selector pins labelled - A, B, C & D.

The presence or absence of the selector pins determines the chosen setting.

Figure 1 shows selector pin A removed.

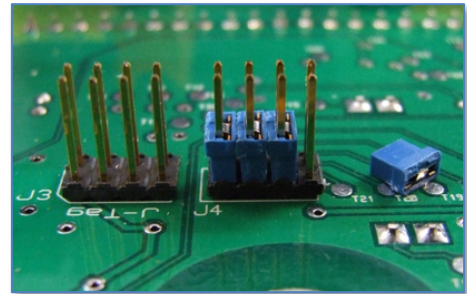

Figure 1

TVOC 2 ships with all four selector pins fitted as shown in Figure 2.

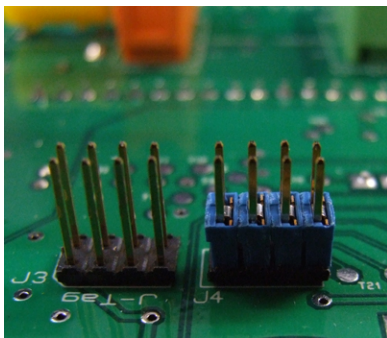

Figure 2

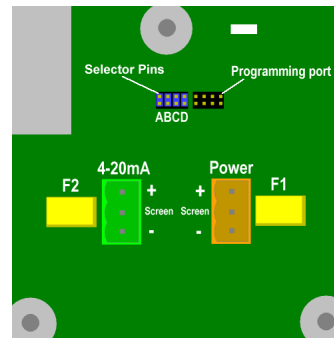

Figure 3

The following table shows the selector pin combinations and the corresponding function.

✓ = Selector pin fitted

✗ = Selector pin removed

Selector pin				Range	Displayed units
A	B	C	D		
✓	✓	✓	✓	1000	ppm (Default)
✓	✓	✗	✓	100	ppm
✓	✗	✓	✓	10	ppm
✓	✓	✓	✗	2280	mg/m ³
✓	✓	✗	✗	228	mg/m ³
✓	✗	✓	✗	22.8	mg/m ³

Selector pin 'B' and 'C' selects the ranges - 10 ppm, 100 ppm or 1000 ppm

Selector pin 'D' selects the units - "ppm" or "mg/m³"

Selector pin 'A' - Fault output range

NOTE: During an Alarm condition (F1 or F2), the output will drop to either 3.5 mA or 2.0 mA.

Jumper 'A' fitted: 3.5 mA during an alarm condition.

Jumper 'A' removed: 2.0 mA during an alarm condition.

By default, the TVOC 2 has a factory calibration of 100 ppm.

NOTE:

- TVOC 2 is shipped with ALL selector pins fitted as standard
- TVOC 2 only reads the selector pin settings when power is connected.
- Always ensure power is disconnected from TVOC 2 before changing settings or carrying out maintenance.
- Never place selector pins on the programming port connector.
- Ensure static build-up is discharged before touching components.
- If the selector pin setting is not recognised, then error F4 will occur. To recover, switch the instrument off, select the correct jumper, and switch it back on.

Installation

Location

There are many variables involved in defining the optimum location for a gas detector. Obvious though it may sound, the most important rules are:

- A detector will not detect gas unless gas reaches the detector.
- TVOC 2 should be mounted in the location most likely to detect gas.
- TVOC 2 must be mounted vertically with the sensor underneath the case. This prevents water, dust, and debris from blocking access to the detector cell.
- If possible, mount TVOC 2 near the ceiling to target VOC gases that are lighter than air or just above floor level to detect VOC gases that are heavier than air.
- Mount TVOC 2 in an area that has good air circulation. Restricting natural air currents may delay detection.
- Never mount TVOC 2 in direct sunlight or over a heat source such as a radiator. This may cause the unit to exceed its certified working temperature range.
- Do not mount TVOC 2 in areas likely to flood.
- Mount TVOC 2 units in locations that are easily accessible for servicing.
- Percentage variations in the composition of air (78 % Nitrogen, 21 % Oxygen and 1 % Argon) may affect the detected signal.

NOTE: Please refer to the instrument's technical specifications in this manual before beginning a TVOC 2 installation.

Cable and Gland Requirements

The screw terminal sockets for connecting wires in the TVOC 2 accept wires of 0.5 mm² to 2.5 mm² Cross-Sectional Area (CSA)

Screened cables for both power and signal out are necessary to achieve EMC compliance. Cable screens must be terminated at both ends to be effective in achieving electromagnetic compatibility (EMC). The screens should be terminated to the TVOC 2 enclosure using EMC-compatible cable glands. An EMC-compatible gland must make electrical contact with the enclosure. This is usually done using a serrated washer or EMC lock nut that bites through the paint, making electrical contact. EMC lock nuts

have been provided. These locknuts are orientation specific. The points should be facing the case to cut through the paint during tightening.

Two M20 cable glands and one blanking plug have been supplied as standard to ease installation in most circumstances. These parts will not be appropriate for all applications; they should be used at the discretion of the installation engineer. It is recommended that the manufacturer's instructions be followed for the installation of the gland and blanking plug. The M20 blanking plug has been included to enable installations using a single cable entry (for example, a three-wire system) to be implemented.

While ION Science cannot recommend the cable gland suitable for every application, the following information may be helpful for the installation engineer in selecting the appropriate type:

- For intrinsically safe operation using safety barriers, the only requirements on the cable glands are that they are better than IP20 rated. This may seem extraordinary; however, when the power is safely limited to the TVOC 2, it is intrinsically safe and does not rely on preventing dirt or moisture from entering the enclosure.
- For safe operation in Zone 2 without safety barriers, cable glands must be ATEX or IECEx rated (Ex e, Ex n or Ex d) and at least IP54.

Installation of the TVOC 2 depends on the installer's preferences, intrinsically safe operating legislation, and the application.

ION Science suggests connecting the screens via cables using a gland, as shown in the diagrams and in the Installation Section of this manual. However, there might be technical circumstances where a connection to the PCB is necessary.

Dimensions for Mounting

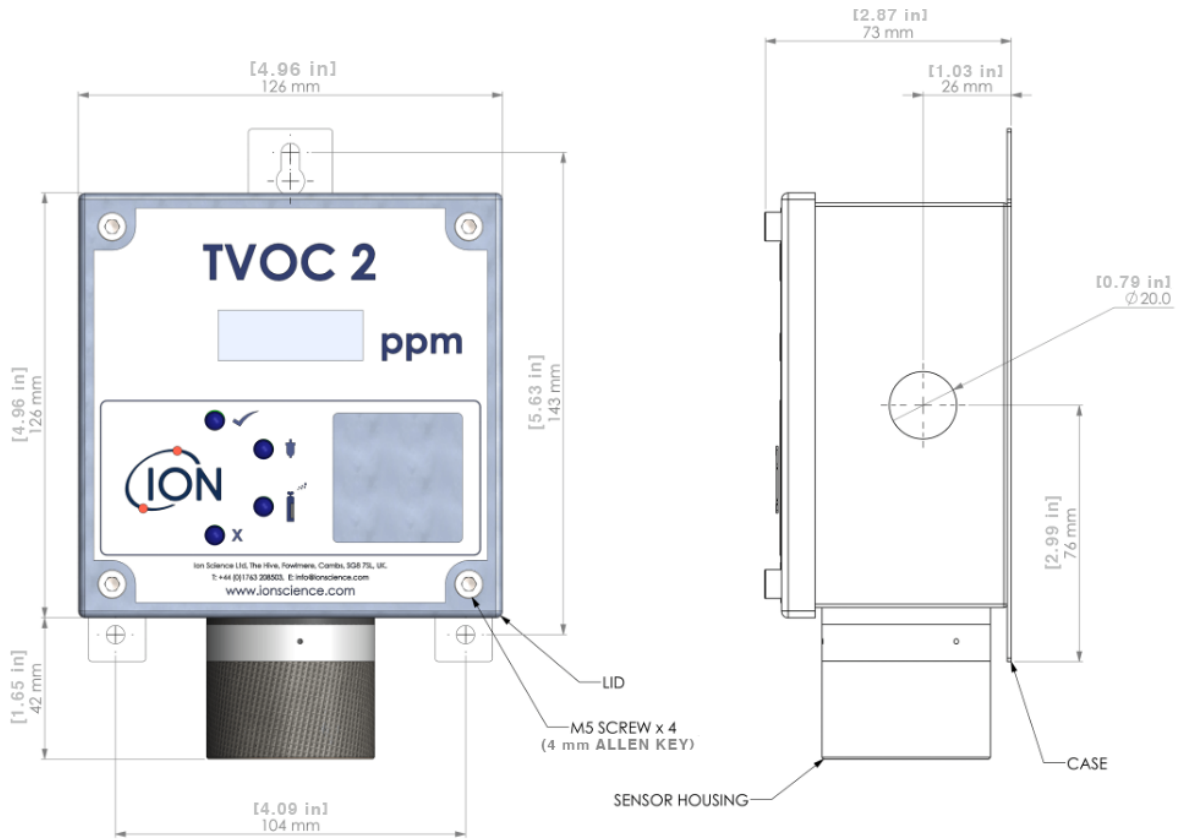

Figure 4

NOTE: The TVOC 2 case can be used as a template when marking out fixing holes, but do not drill through them.

Power Requirements

Non-Intrinsically Safe Operation applications:

Input power 5-28 Vdc. 130 mA max. (0.5 to 2.5 mm² CSA)

Output power (4-20 mA) 8-35 Vdc. 80 mA max. (0.5 to 2.5 mm² CSA)

NOTE: 4-20 mA loop must be externally powered.

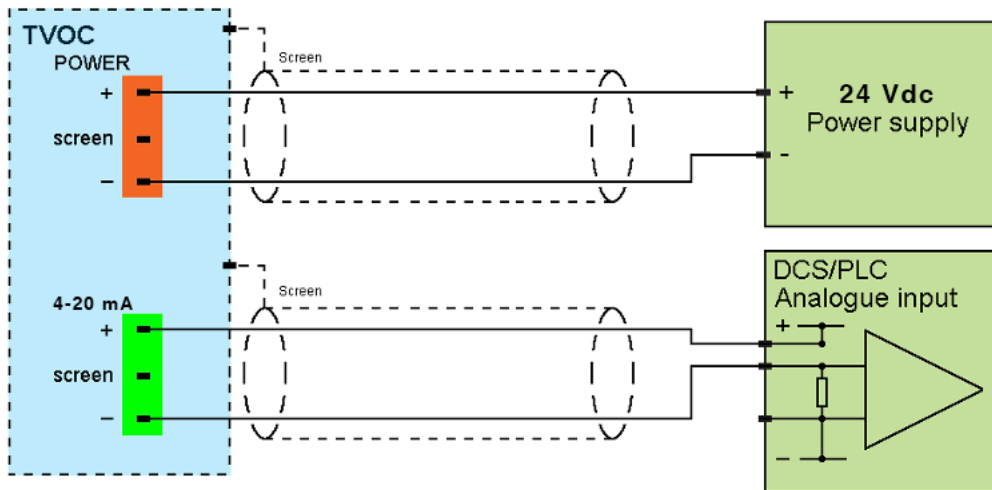

Figure 5 - 4 Wire System (Non-IS)

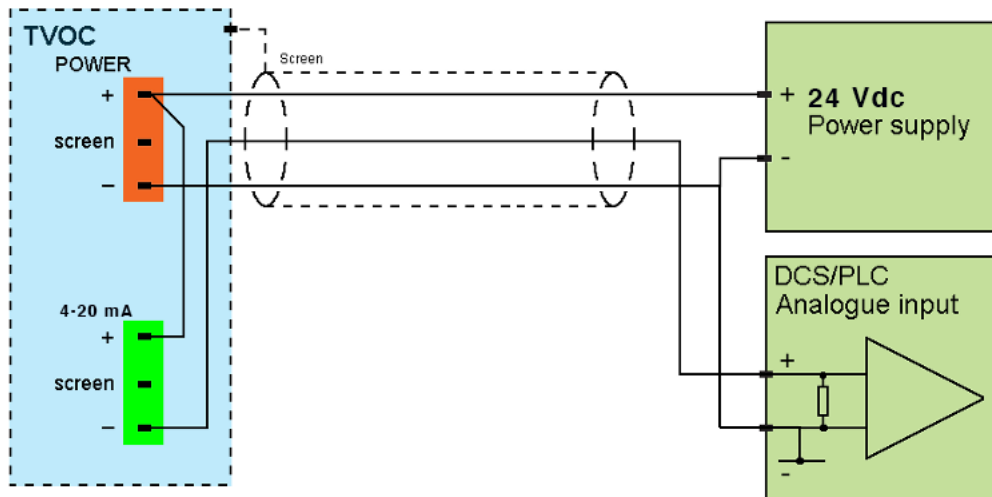

Figure 6 - 3 Wire System (Non-IS)

WARNING:

The label on the enclosure details both Zone 1 and Zone 2 certifications. The appropriate section of the Intrinsically Safe label should be covered up or blocked out to reflect the type of installation. For Non-intrinsically Safe applications, the label should be completely covered. For Zone 2 applications without safety barriers, the ia certification details should be blanked out. For Zone 1 or Zone 2 IS applications with safety barriers, the nA certification details should be covered. This will prevent future safety discrepancies should the equipment be moved or the site be redefined as a hazardous area.

Entry parameters for Zone 2 only, nA (non-sparking) areas:

Input (Power) $U_i = 24\text{ V}$

Output (4-20 mA) $U_i = 35\text{ V}$

For information only: please see the Intrinsically Safe operation certificate before installation.

The wiring of Zone 2 systems is identical to the wiring shown for non-intrinsically Safe applications. The only difference is the requirement to ensure that the power supply used provides 24 V or less in normal operation.

Entry parameters for Intrinsically Safe, Zone 1 or Zone 2 installations:

Input (Power)	$U_i = 18\text{ V}$	$I_i = 800\text{ mA}$	$P_i = 1.2\text{ W}$	$C_i = 0\mu\text{F}$ $L_i = 0\text{mH}$
Output (4-20 mA)	$U_i = 30\text{ V}$	$I_i = 200\text{ mA}$	$P_i = 1.2\text{ W}$	$C_i = 0\mu\text{F}$ $L_i = 0\text{mH}$

NOTE: Please see the Intrinsically Safe certificate before installation.

ION Science suggest using Zener barriers for IS-approved applications. Use competent installation engineers and ask them for installation and application advice.

WARNING: Intrinsically Safe (IS) and Zone 2 applications

- Units should not be powered using non-IS power supplies before installation in an IS application.
- If non-IS power is supplied, the unit will require inspection by ION Science or an ION Science Approved Service Centre before installation in an IS application.
- TVOC 2 fuses may not be replaced in the field.
- If a fuse is blown, TVOC 2 will require inspection by ION Science or an ION Science Approved Service Centre before it is used in an IS application.

WARNING: Potential Electrostatic Charge Hazard

The unit should be installed and maintained to avoid the build-up of electrostatic charge on the front label:

Do not install TVOC 2 where it will be brushed by fabric.

Clean only with a damp cloth.

WARNING: Cable glands or blanking plugs must be fitted.

WARNING: DO NOT REMOVE OR REPLACE FUSE WHEN ENERGISED.

CAUTION: The unit must be installed with the opening in the sensor housing pointing downwards.

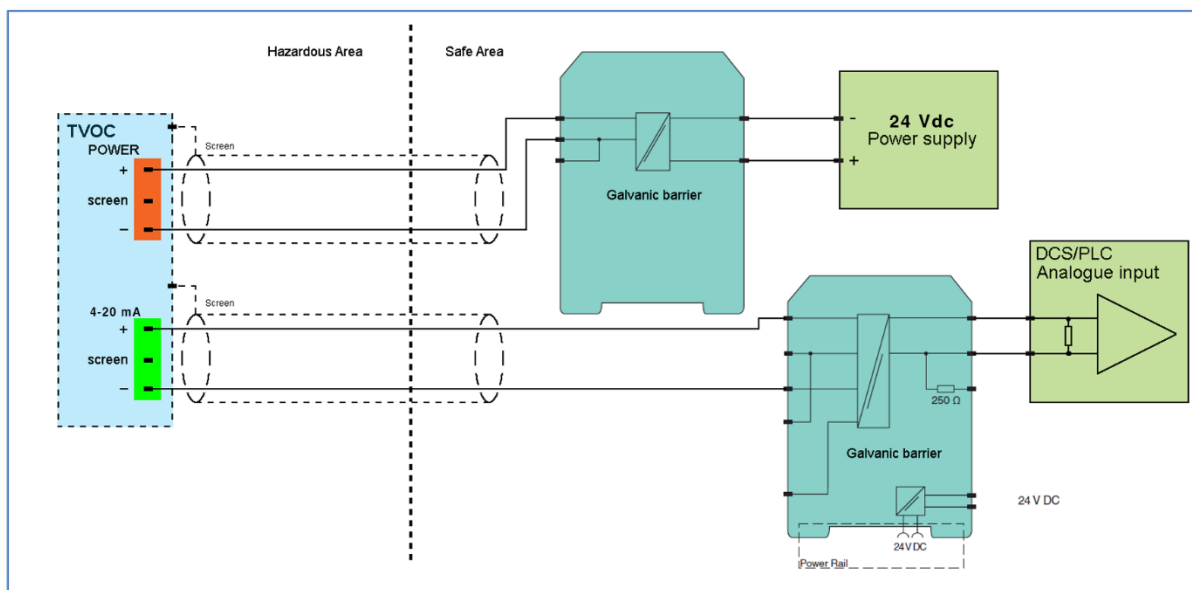

Figure 7 - 4-wire Control equipment sensing 4 – 20 mA on return line

NOTE: For intrinsically safe installations, the enclosure may be opened while the system is live, provided the work is undertaken by competent personnel and suitable safety precautions are taken.

Initial Calibration

TVOC 2 is calibrated at ION Science before dispatch using 100 ppm Isobutylene. However, if you wish to calibrate your TVOC 2 after installation, ION Science recommends leaving the unit running on its chosen settings (see 'TVOC 2 Set-up Section') for 24 hours before performing an initial calibration, to allow the instrument to stabilise.

NOTE: If the 0-10 ppm range is selected, the TVOC 2 will require calibration using 10 ppm Isobutylene before use (See the calibration section of this manual).

Operation

Start-up

After electrical power is connected, TVOC 2 runs through a 'Start-up' routine that lasts approximately 1 minute. During this 'Start-up' routine, TVOC 2 demonstrates the following characteristics:

- The LCD screen displays the software version number
- The green LED flashes
- The 4-20 mA output is set to 4 mA (0.0 ppm)

Update Rate: TVOC 2 has a fixed output update rate of one second.

Calibration Gases

TVOC 2 has three selectable ranges; however, the 0-10 ppm range requires the instrument to be calibrated by the user before use. The 0-100 ppm and 0-1,000 ppm ranges can initially be run using the Factory calibration.

If the 0-10 ppm range is selected, TVOC 2 will display the following screen to indicate that a calibration is required before it can be used see Figure 9.



Figure 9

Follow the calibration instructions before use.

NOTE: The 0-10 ppm range is more sensitive to environmental and system tolerances. Therefore, the instrument must be calibrated before use.

Calibration Routine

ION Science recommends calibrating TVOC 2 after any maintenance or lamp cleaning, and on a 3-monthly basis, to ensure it is working to specification.

NOTE: Please read this entire calibration procedure before attempting a calibration.

TVOC 2 calibration is undertaken in three steps:

- | | |
|---|--|
| 1. Setting the ZERO | (Using clean gas via carbon filter) |
| 2. Setting the span gas concentration ranges) | (1 – 200 ppm Isobutylene on 0-100 ppm and 0-1000 ppm ranges) |
| | (0.1 – 20.0 ppm Isobutylene on the 0-10 ppm range) |
| 3. Setting the SPAN | (Using the SPAN gas) |

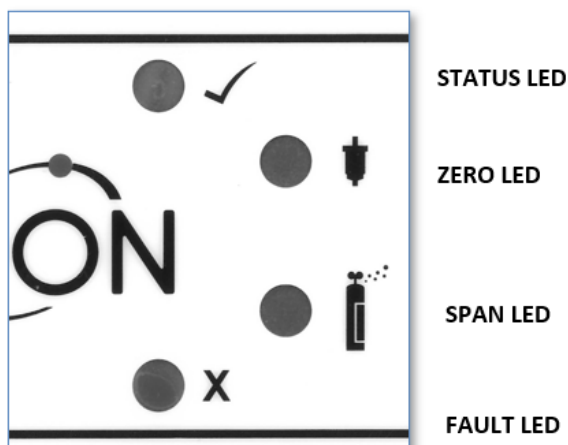

Figure 10

Setting the ZERO

1. Place the calibration magnet over the ION Science logo to enter calibration mode. The 'ZERO LED' will illuminate and the 'STATUS LED' will extinguish.
2. Remove the calibration magnet
3. Insert the calibration adaptor into the sensor cap and attach the carbon filter to the calibration adaptor. The carbon filter should be connected to the hand aspirator (See Figure 11).
4. Again, place the calibration magnet over the logo.
5. Slowly and repeatedly squeeze the hand aspirator to push clean air through the carbon filter and past the PID sensor. The 'ZERO LED' will stop flashing after approximately 30 seconds.
6. Now remove the equipment except for the calibration adaptor.

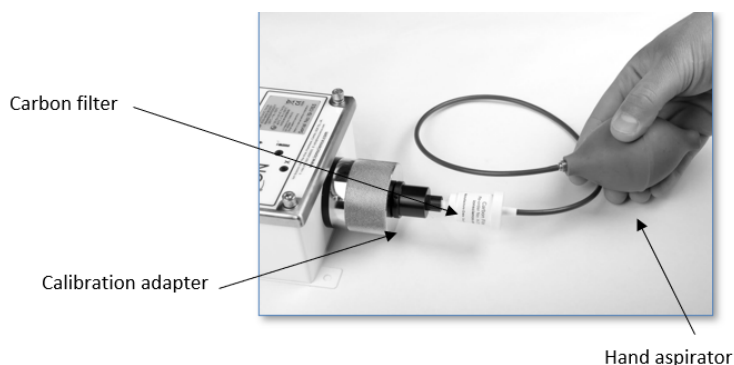

Figure 11

The 'ZERO LED' will flash during this stage. The TVOC 2 displays a direct millivolt (mV) output from the PID sensor. The zero mV reading must fall below 100 mV.

An acceptable ZERO calibration level will result in the 'STATUS LED' being illuminated.

An unacceptable ZERO calibration level will result in the 'FAULT LED' being illuminated. Should this occur, the TVOC 2 will not proceed to the gas tolerance setting and return to normal operation; the previous calibration levels will be used. The yellow 'ZERO LED' will be illuminated to indicate that a zero-calibration level was not set.

Setting Span Gas Concentration

1. Place the calibration magnet over the logo – The green 'STATUS LED' will be extinguished, and the numeric display will start to flash.



Figure 12

2. If the 0-10ppm range is selected, you will be able to adjust between 0.1 ppm and 20ppm. For both the 100 ppm and 1000 ppm ranges, a concentration of between 1 and 200 ppm can be selected. Leaving the magnet in position will cause the displayed number to cycle through the concentration. Remove the magnet when the displayed value matches that stated on the calibration gas bottle. Should you miss the desired reading, quickly reapply the magnet to continue scrolling through the numbers, then remove it at the desired reading.

- The selected number will be recorded 5 seconds after the removal of the magnet when the display stops flashing. The display will initially show 100. Should this be the desired reading, remove the magnet straight away. (See **Error! Reference source not found.**)

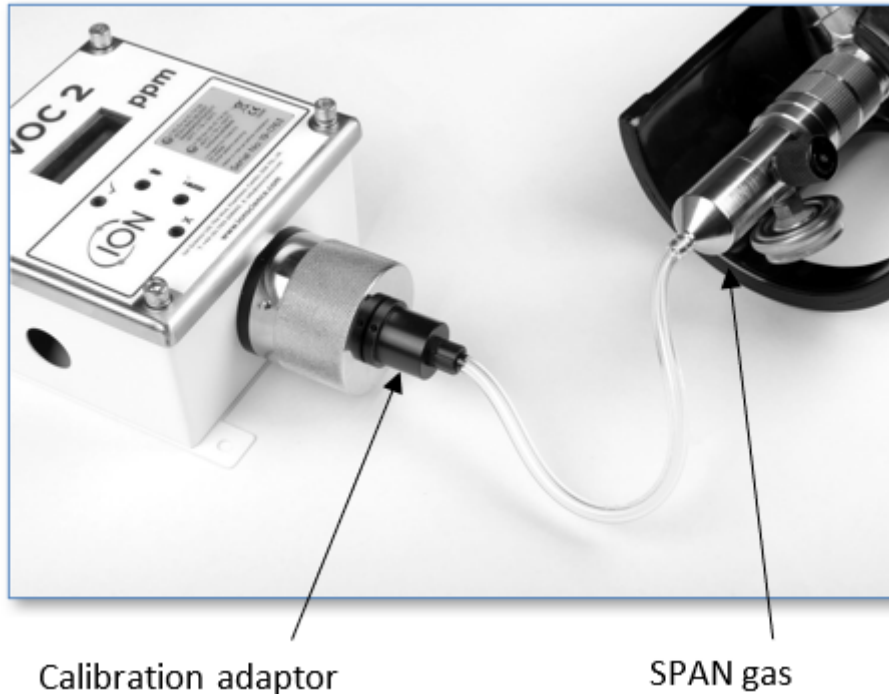

Figure 13

Setting the SPAN

Connect the SPAN gas to the calibration connector, then the connector to the adaptor (See Figure 13)

Switch on the gas supply, wait for the numbers on the screen to increase by 2s, then place the magnet over the logo.

- The yellow 'SPAN LED' will flash, and TVOC 2 will display the PID sensor's direct millivolt (mV) output. Now remove the magnet. The Span mV reading should be more than 150 mV if using 100 ppm isobutylene. The span mV reading should be at least 500 mV if using 1000 ppm isobutylene.
- The 'SPAN LED' will stop flashing after approximately 2 minutes and 30 seconds.
- Now place the magnet over the logo to confirm calibration.
- Leave the gas connected.
- The instrument will now go through its first cycle (the green LED will be flashing). The LCD should display the gas concentration used during calibration, e.g., 100 ppm.

NOTE: If the fault LED is flashing at the end of a cycle, another calibration is required.

Calibration

An acceptable SPAN calibration level will result in the illumination of the green 'STATUS LED'.

An unacceptable SPAN calibration level will cause the red 'FAULT LED' to illuminate. Should this occur, the previous calibration levels will be used when the instrument returns to regular operation. The Yellow 'SPAN LED' will be illuminated to indicate the failure to calibrate the span.

NOTE: During the span measurement process, the mV reading of the span must be greater than the zero level to pass the SPAN calibration stage.

The green 'STATUS LED' will begin flashing as TVOC 2 starts.

NOTE:

- Always check the accuracy of your calibration by checking readings from TVOC 2 when it is running normally using the ZERO filter and SPAN gas.
- Accuracy of calibration is the responsibility of the person carrying out the calibration. If in doubt, seek advice.
- TVOC 2 must be calibrated after lamp/cell cleaning or general maintenance.

Causes of contamination and error in the signal:

- Changes in air pressure when detecting ppm concentration
- Variation in oxygen and argon beyond ambient levels.
- Variation in ambient moisture content

Bump Test

To perform a bump test on the TVOC 2 instrument, apply the test gas and wait at least 2 minutes and 30 seconds (or until the readings **stabilise**) before taking a measurement.

NOTE: If the TVOC 2 reading does not closely match the applied gas concentration, recalibrate the instrument.

Maintenance

Cleaning the MiniPID 2

TVOC 2 has been designed to ensure servicing is quick and easy:

1. Before servicing TVOC, disconnect the electrical power to the instrument.
2. Remove the locking screw from the metal sensor cap using the Allen key supplied in the TVOC 2 Accessory Kit - part number A-849214 (see Figure 14).

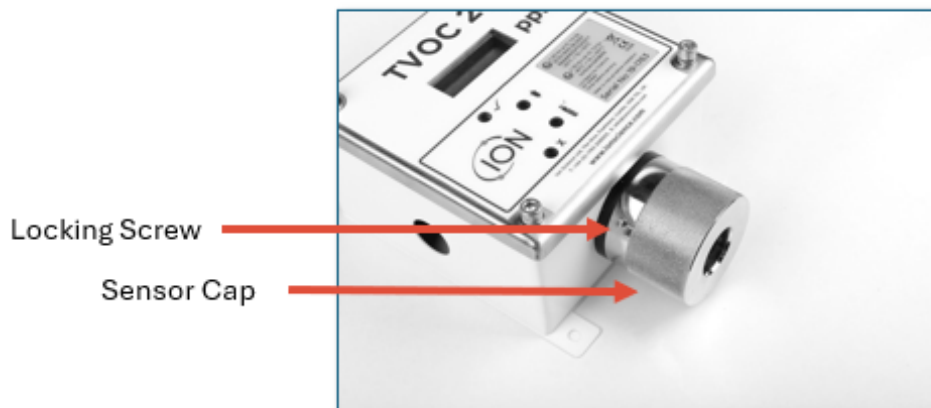

Figure 14 – TVOC 2 sensor cap and locking screw

- Remove the MiniPID 2 using the MiniPID 2 removal tool. Be careful when withdrawing it; don't twist when the MiniPID 2 is in the Sensor Housing. Only light force is required.

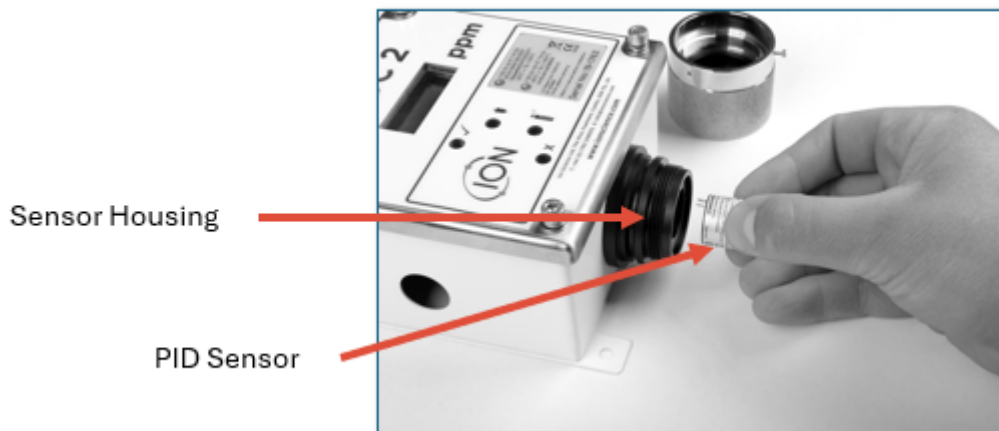

Figure 15 – MiniPID 2 being removed from the TVOC 2 sensor housing



CAUTION

Failing to remove the locking screw before unscrewing the sensor cap will damage the sensor holder.

- Use the electrode stack removal tool to remove the electrode stack.
- Remove the Electrode Stack and PID Lamp by holding the MiniPID 2 upside down.

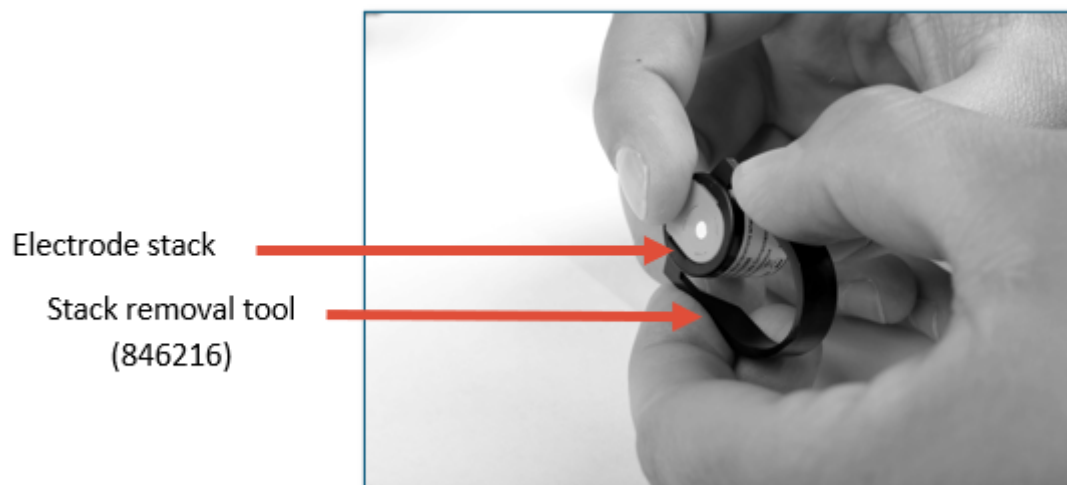

Figure 16 - Electrode stack removal



CAUTION

Ensure the Electrode Stack and PID Lamp land on a soft surface, such as tissue paper. This will prevent damage to the parts as they fall out and avoid finger contact with the PID Lamp window.



CAUTION

Only use the electrode stack removal tool. Any other tools (e.g., screwdrivers) may damage your MiniPID 2 body and invalidate your warranty.

- Clean the PID Lamp using the PID lamp cleaning kit (A-31063).

To Clean the PID Lamp

1. Open the vial of Aluminium Oxide polishing compound. With a clean cotton bud, collect a small amount of compound.
2. Use this cotton bud to polish the PID Lamp window. Use a circular action applying light pressure to clean the lamp window. Never touch the lamp window with your fingers.
3. Continue polishing until an audible “squeaking” is made by the cotton bud with compound moving over the window surface (usually within fifteen seconds).

Remove the residual powder with a short blast of air from the air duster.



INFORMATION



Contamination of the PID Lamp window can significantly reduce the MiniPID 2's detection capability, even when the contamination is not visible. Cleaning of the lamp should be carried out regularly, depending on the PID Lamp (7) and the environment.

The air's humidity and contaminants may affect the time between services.

4. The Electrode Stack should be inspected for visible signs of contamination. If contamination is visible, the Electrode Stack must be replaced.

For more information on servicing your MiniPID 2 sensor, watch our [tutorial video](#).

Reassembly

1. Lay the Electrode Stack front face down on a clean, flat surface and then screw the lamp down into the O-ring until it firmly abuts against the front electrode face.
2. Place the MiniPID 2 body carefully down over the lamp-stack sub-assembly so as not to disturb its seating within the electrode stack, then push the body firmly onto the face-down Electrode Stack so that both wings engage with the MiniPID 2 body.
3. Inspect the sensor to confirm that both wings of the electrode stack have engaged with the MiniPID 2 body.
4. Refit the sensor into the sensing instrumentation.



Figure 17 - Seating the MiniPID 2 back into the TVOC 2 sensor housing

5. Ensure that the stack is at a 12 o'clock position before inserting the sensor. It should insert into the connectors easily. If significant resistance is felt, remove and check alignment before re-inserting.
6. The TVOC 2 must be calibrated.

**CAUTION**

Irreparable damage will result if the MiniPID 2 is forced into the Sensor Housing if it is not correctly aligned.

**WARNING**

Do not assemble using a damaged lamp, as this may rupture the stack's lamp O-ring seal.

**INFORMATION**

Always calibrate the TVOC 2 after servicing.

Use of PID Lamp Cleaning Kit A-31063

The container of cleaning compound contains Aluminium Oxide, a fine powder (CAS Number 1344-28-1).

The Compound has a TVL (TWA) of 10 mg/m³ and a complete material safety data sheet MSDS is available on request from Ion Science. The key issues are listed below.

Hazard identification

May irritate the respiratory tract and eyes.

Handling

- Do not breathe the vapour/dust.
- Avoid contact with skin, eyes, and clothing.
- Wear suitable protective clothing.
- Follow industrial hygiene practices:
 - Wash face and hands thoroughly with soap and water after use and before eating, drinking, smoking, or applying cosmetics.
- Always replace the lid after using the cleaning compound.

Storage

Keep the container closed to prevent water adsorption and contamination.

Fuse Rupture and Replacement

TVOC 2 features a 125 mA BASEEFA-certified fuse to provide intrinsically safe protection when installed in hazardous areas.

A fuse may rupture due to overvoltage or a current surge. Replacement procedures depend on the application type:

For Intrinsically Safe (IS) or Zone 2 applications:

- The unit **must** be returned to Ion Science or an Ion Science-approved Service Centre for fuse replacement and inspection
- **The intrinsically safe rating is not maintained if the fuse is replaced by unauthorised personnel**
- Do not return the unit to hazardous area service until proper inspection and certification is completed

For non-IS applications:

- The fuse may be replaced with an equivalent-rated fuse by qualified engineering personnel
- Operation must be tested and verified after replacement

Warning: Never attempt to replace fuses in IS-rated equipment in the field. Only authorised service centres can maintain intrinsic safety certification.

System Recommendations

TVOC 2 is typically used to measure gas concentrations in ambient air. The sensor is open to the atmosphere and any gas that diffuses or moves under convection into the locality of the TVOC 2 sensor will be detected. Generally, the ambient environment in which TVOC 2 is located is readily accessible, but the applications listed below require special consideration.

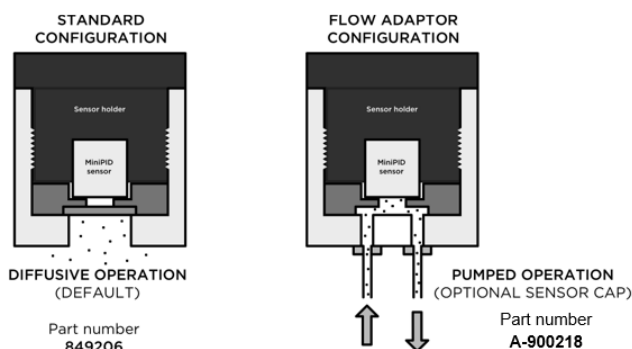

Figure 18

Gas Sample Systems

It is sometimes necessary to pump or draw a gas sample past the TVOC 2. For this a “Flow Adaptor can be fitted. The flow adaptor has an inlet and an outlet port so that gas may be pushed or drawn across the sensor. (See **Error! Reference source not found.** above)



A-900218



TVOC 2 Flow Adaptor Cap Assembly (A-900218)

NOTE: The Flow Adapters for TVOC and TVOC 2 are different parts.

Flow Adapter Fitting Instructions

Replace the metal cap with the flow adapter, re-using the plastic seal disk with its O-rings. The light guard is not required.

The flow adapter cap has M5 threaded holes for use with standard pipe fittings.

For a gas sample system, we have the following recommendations:

1. Where possible, use the Flow Adaptor that Ion Science sells. This has an integral O-ring to seal the sensor housing and ports for connection of inlet and outlet sample tubes. Please refer to the spare parts section for the part number.
2. The pressure difference of a pumped system relative to the atmosphere should be minimised to avoid the effects of the gas law.
3. The maximum pressure that can be applied to the TVOC 2 sensor housing is 300 mbar. However, this is not a recommended working pressure. Ideally, the working pressure should be ± 30 mbar relative to ambient pressure.
4. In line flow restrictions must be minimised. Flow restrictions cause differential pressures, which can directly affect the TVOC 2 reading. If flow restrictions are unavoidable, the flow rate should be reduced to minimise pressure effects; however, this will increase the response time.
5. A flow between 250 and 500 ml/min is recommended for calibration. This will ensure a prompt response to applied gas.
6. The working flow should be very similar to that used to calibrate the instrument, or errors in output will occur (see point 2).

7. The response time of the system is defined by the sensor response rate and sample flow rate, which, in combination with the tube length and diameter, as well as any dead volumes.

Quality Assurance

Ion Science Limited manufactures TVOC 2 instruments within an ISO 9001-compliant quality system, which ensures that the equipment supplied to our customers is designed and assembled reproducibly from traceable components.

Warranty

Instrument

1 Year standard warranty. To receive your 2 Year Warranty, you must register within one month of purchase (Terms and Conditions apply). You will then receive a confirmation email that your Warranty Period has been activated and processed.

Lamp

12 months standard warranty from the date of sale by ION Science.

Full details, along with a copy of our Warranty Statement, can be found by visiting: www.ionscience.com

Service

ION Science is pleased to offer a range of service options for our TVOC 2 product line, allowing you to choose the instrument cover that best suits your needs.

At ION Science, we recommend that all our gas detection instruments be returned for service and factory calibration once every 12 months.

Contact ION Science or your local distributor for service options in your area.

Diagnostics

Below are two conditions your TVOC 2 can be in when it is working correctly:

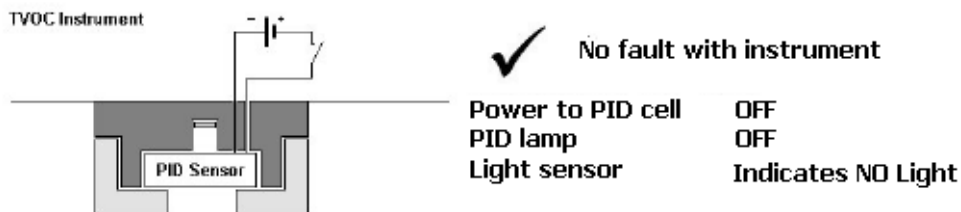
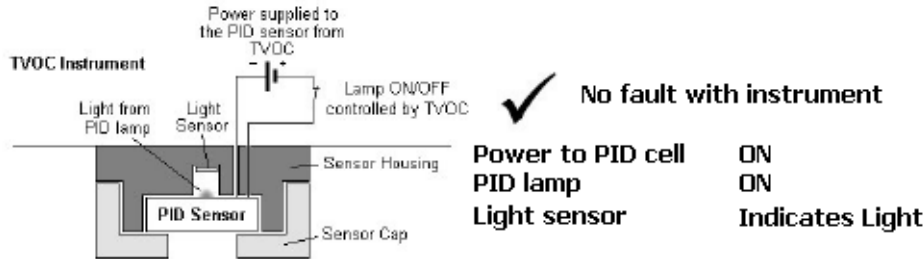

The conditions shown below are of the instrument in an error state with potential checks/cures for these faults:

F1 Error

If an F1 error occurs when the instrument is first switched on there may not be an issue. The instrument needs to be left on for a few cycles to see if the lamp strikes on its own. If an F1 error is still on screen after 5 minutes, look at the information below.

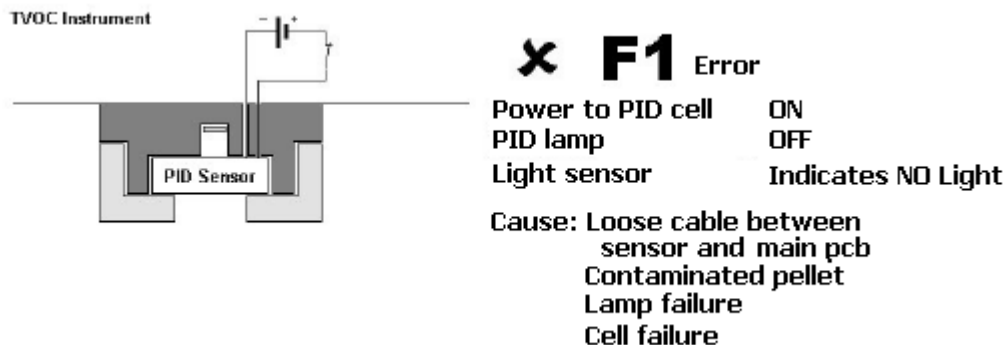

If the F1 error persists for more than 5 minutes, first check that the red cable between the sensor PCB and the main PCB is securely connected.

If the F1 diagnostic persists, replace the sensor electrode stack, part number A-846496, re-power the instrument and wait 5 minutes. If the F1 error persists, replace the sensor lamp (part number A-846656). Electrode stack and lamp spares are identified in the spare parts section below.

If the instrument continues to exhibit the F1 failure after parts are replaced, please contact your ION Science distributor.

F3 Error

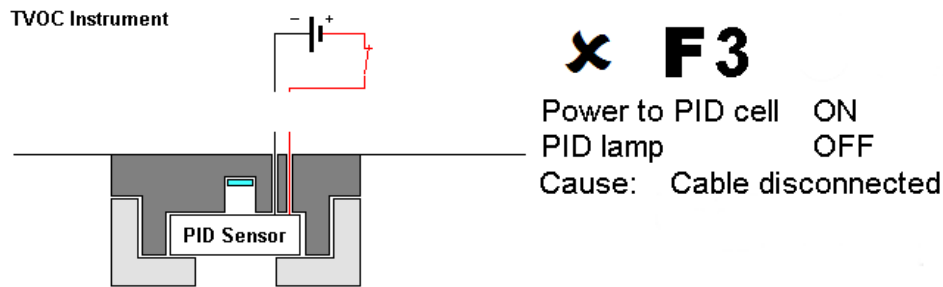

The F3 error occurs when the sensor is disconnected from the power supply. If an F3 error occurs, then check the red cable is correctly connected to the main PCB. If not, push it fully home.

F4 Error

The F4 error occurs when an incorrect selector pin setting is used, see TVOC 2 Set-Up. Set a valid selector pin configuration and restart the unit.

Spare Parts and Accessories

TVOC 2 Tool Kit (A-849214)

Item	Description	Qty
1	Calibration magnet	1
2	Calibration adaptor	1
3	Calibration connector	1
4	Aspirator	1
5	Carbon filter	1
6	Allen keys	2

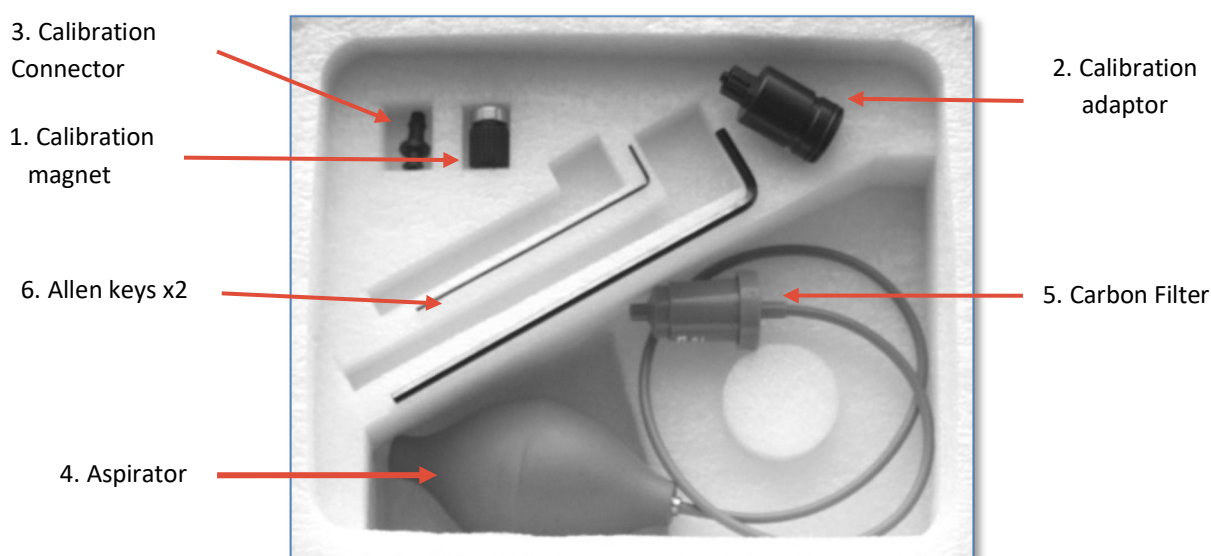

Spare List

Part	Description	Part Number
TVOC 2 Tool Kit	Calibration magnet, Calibration adaptor, Calibration connector, zero gas aspirator, carbon filter, 2 x Allen keys	A-849214
Flow adaptor (TVOC 2 only)	Replaces the standard sensor cap	A-900218
PID Lamp cleaning kit	Replaces the standard sensor cap	A-31063
Span Gas kit (100 ppm)	100ppm Isobutylene (103Litres) and a flow regulator in a carry case	A-845213
Span Gas kit (10 ppm)	10ppm Isobutylene (103Litres) and a flow regulator in a carry case	849230
PID Sensor	Replacement PID Sensor	MP6SDL6XU2
O-Ring for Sensor Light guard	Fits to the outside of the Seal Disc, seals to the housing	5/OV-11
O-Ring for MiniPID 2 Gas Port	Fits between MiniPID 2 and the Seal Disc	5/00-108
Calibration Adaptor	For connecting to the standard cap for calibration	A-849209
Stack Removal Tool	Mini PID Electrode Stack Removal Tool	846216

Technical Specifications

PID Sensor	ION Science MiniPID 2	
Lamp type	10.6 eV (Krypton)	
TVOC 2 enclosure ingress protection	IP65	
Sensor ingress protection	IP54	
Ranges	0 – 10 ppm / 0 – 22.8 mg/m ³ (0.01 resolution)	
	0 – 100 ppm / 0 – 228 mg/m ³ (0.1 resolution)	
	0 – 1,000 ppm / 0 – 2280 mg/m ³ (1.0 resolution)	
Non-IS applications:	Input power	5 – 28 Vdc. 130 mA (0.5 mm ² to 2.5 mm ² CSA)
	4 – 20 mA	8 – 35 Vdc. 22 mA (0.5 mm ² to 2.5 mm ² CSA) 4-20mA loop must be externally powered

Zone 1 or Zone 2 Intrinsic Safe Installation

Approval Marking	⊕II 2G Ex ia IIC T4 Gb (-20 °C ≤ Ta ≤ +50 °C)
IECEX Certificate number	IECEX BAS 06.0057X
ATEX Certificate number	Baseefa05ATEX0277X
IS Input parameters	Input power: Ui = 18V, li = 800mA, Pi = 1.2W, Ci = 0μF, Li = 0mH
	4-20 mA Ui = 30V, li = 200mA, Pi = 1.2W, Ci = 0μF, Li = 0mH
	(For information only, please see the certificate before installation)
Zener Barriers are required.	Ask your installation engineers for advice on installation and application.

Manual Log

Manual Version	Amendment	Date updated	Instrument Firmware	PC Software
TVOC 2 Manual V1	New document for TVOC 2 instrument based on V4.7 of the original TVOC manual	04/07/19	V1.01	N/A
TVOC 2 Manual V1.1	Updated diagrams and Accuracy specification.	24/07/19	V1.01	N/A
TVOC 2 Manual v1.2	Put into new format Added more information to the calibration process Updated diagram 6	11/10/21	V1.01	N/A
TVOC 2 Manual v1.3	<ul style="list-style-type: none"> - Removed reference to the Accessory kit coming as part of the standard kit. - Updating of part numbers to spare parts - DoC reference removed from the user manual and removed reference to self-certification - Updated statements and symbols to align them with Ion Science's latest technical writing standards. - Paragraphs are now clearer, with improvements in consistency and adherence to modern technical writing standards. 	04/04/2026	V1.01	N/A

ION Science Contact Details

ION Science Ltd – UK/Head Office

Tel: +44 (0)1763 208 503

Web: www.ionscience.com | Email: info@ionscience.com

ION Science Inc – USA Office

Tel: +1 877 864 7710

Web: <https://ionscience.com/usa/> | Email: info@ionscienceusa.com

ISM ION Science Messtechnik – Germany Office

Tel: +49 (0) 2104 1448-0

Web: <https://www.ism-d.de/en/> | Email: sales@ism-d.de

ION Science France – France Office

Tel: +33 613 505 535

Web: www.ionscience.com/fr | Email: info@ionscience.it

ION Science Italy - Italy Office

Tel: +39 051 0561850

Web: www.ionscience.com/it | Email: info@ionscience.com

ION Science India - India Office

Tel: +914048536129

Web: www.ionscience.com/in | Email: kschhari@ionscience.com

ION Science China - China Office

Tel: +86 21 52545988

Web: www.ionscience.com/cn | Email: info@ionscience.cn