



Instrument Serial Number

Where to find your instrument Serial Number – V2.3





1. Portable Gas and Leak Detectors	3
Tiger XT Range (2022 to Present):.....	3
Tiger Range (2010 - 2022):.....	4
Panther:.....	5
GasCheck G and GasCheck Tesla:	6
MVI:	7
SF6 LeakCheck P1 XTL Leak Detector.....	8
2. Personal Gas Detectors	9
Cub and Cub TAC:	9
ARA Range:	10
3. Fixed Gas Detectors	11
Falco & Falco TAC Diffused:.....	11
Falco & Falco TAC Pumped:.....	12
Titan 1 & 2:	13
TVOC 2:.....	14
4. Semi-Portable Gas Detectors	15
GasClam 2:.....	15

Our experienced Technical support team are available to help and guarantee a fast response to all customer enquiries, minimising any downtime of your instrument. For any further questions, please contact technical.support@ionscience.com. Alternatively, check out our FAQs on our website! <https://www.ionscience.com/gas-and-leak-detectors/customer-support/faq/>

1. Portable Gas and Leak Detectors

Tiger XT/XTL/XT Select:

For the full Tiger XT Range, you can find the Serial Number on the top left label of the Tiger XT.

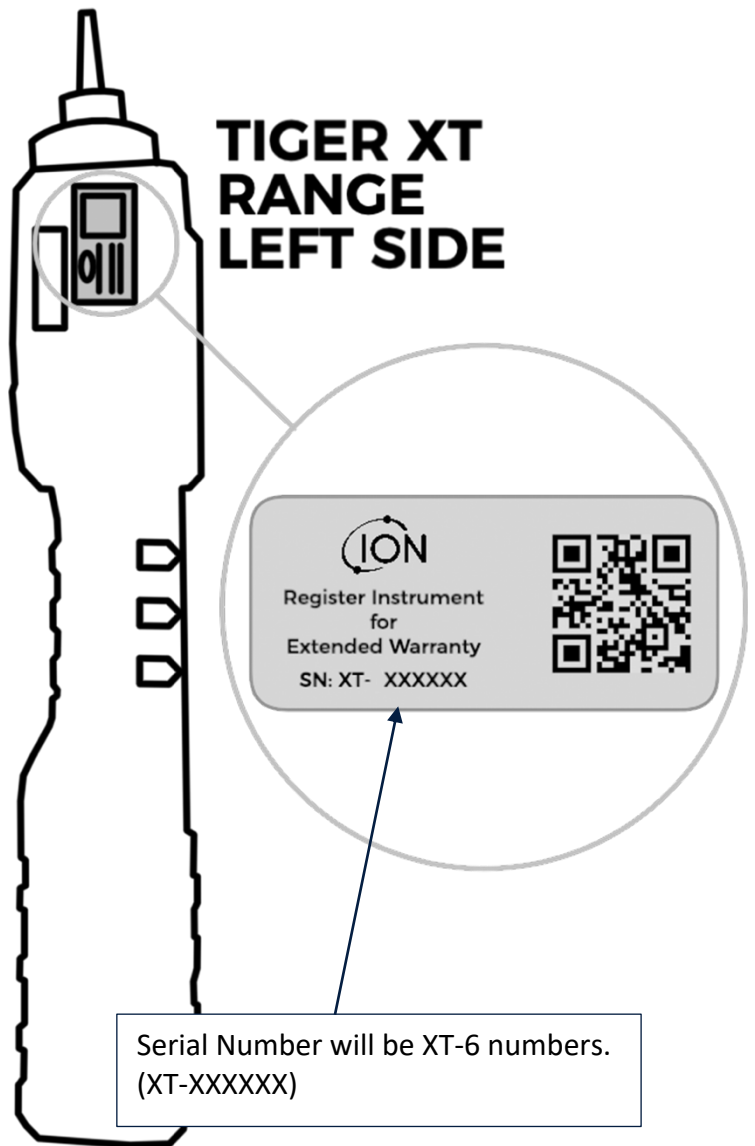

Serial Number will be XT-6 numbers. (XT-XXXXXX)

Tiger Range (2010 – 2022)



If you purchased your Tiger model before 2022, you can find your serial number at the bottom of the instruments front.

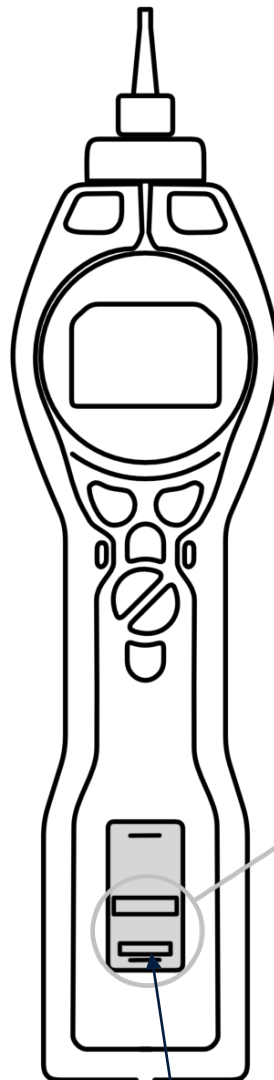

**TIGER
FRONT**

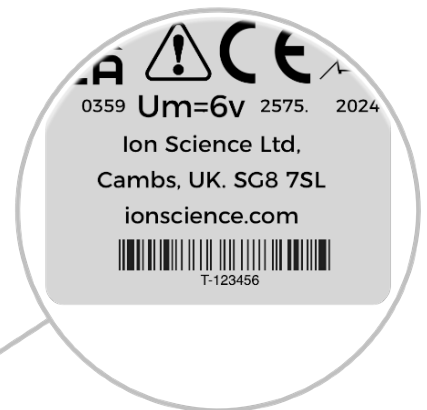

Serial Numbers are located underneath the barcode on the left of the label.
Serial Number will be T-6 numbers. (T-XXXXXX)

Panther:



You can find the Serial Number on the back of the Panther & Panther Pro.

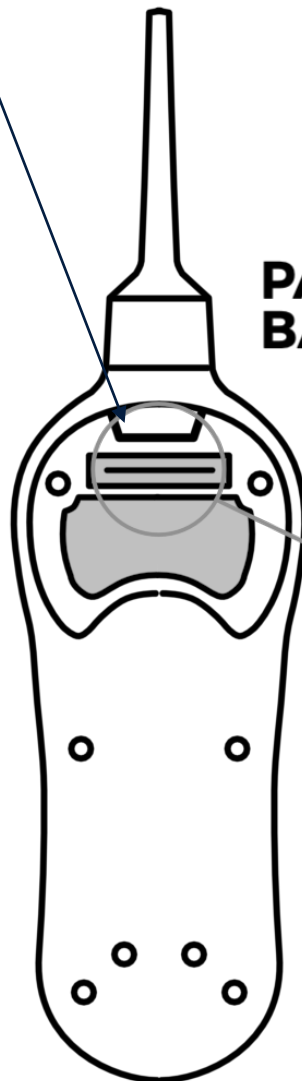

**PANTHER
BACK**

Serial Number : XXXXXXXX

Serial Number will be made up of 8 numbers. (XX[XX]XXXX) The third & fourth number is the year that the instrument was assembled.

GasCheck G and GasCheck Tesla:

The Serial Number is located in the same location as the front 'GASCHECK' label but at the back of the instrument.

GASCHECK BACK

The Serial Number is 2 numbers – 5 numbers. (XX-XXXXX)

Ion Science Ltd, Cambs UK
23-01234

Always use this instrument in accordance with the instructions.

The instrument Serial Number also appears on the second load screen of the GasCheck G and GasCheck Tesla turn on sequence.

GasCheck G3 He	Serial:18-01784 Firmware: V2.25 www.ionscience.com	Zeroing... ⌚
-------------------	--	-----------------

MVI:

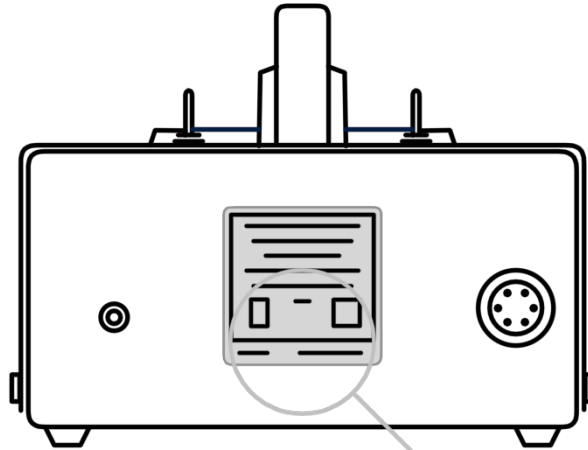

**MVI
BASE**

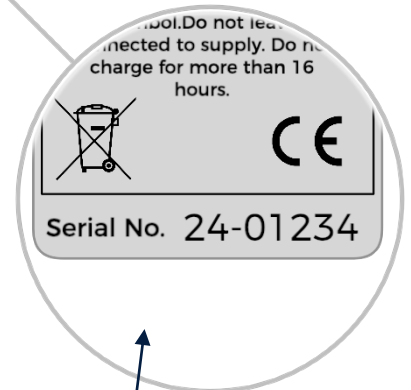

The instrument Serial Number label is located at the base end of the MVI.

The Serial Number is located at the bottom of the label. 2 numbers – 5 numbers (XX-XXXXX)

SF6 LeakCheck P1 XTL Leak Detector



The SF6 LeakCheck P1 XTL has two different serial numbers.

SF6 LEAKCHECK P1 XT- TOP OF CASE

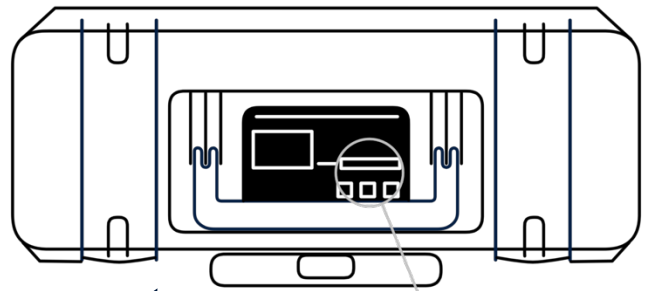

You can find your case serial number of the top of the heavy-duty case.

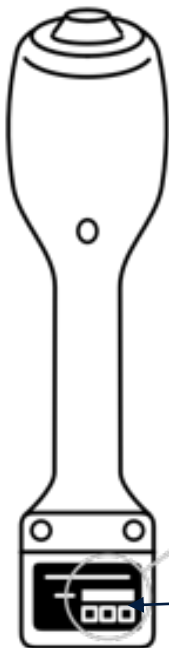

HANDGUN REAR



The handgun serial number can be found on the rear base of the device this will be made up of 6 numbers.

2. Personal Gas Detectors

Cub and Cub TAC:



The Serial Number is located on the right side of the instrument if you are looking at it face on.

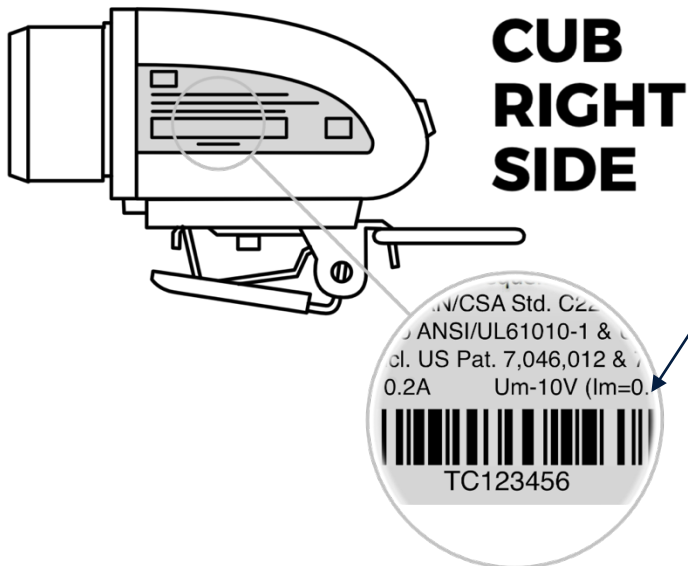

The Serial Number is located underneath the barcode. TC – 6 numbers (TC-XXXXXX)

ARA Range:

Please note: ARA Range is not included in our extended warranty, but there are hibernation models available to extend the device lifespan.

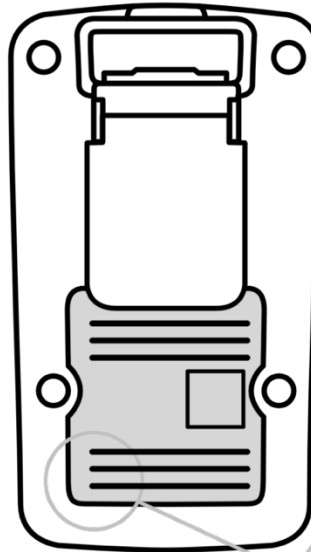

**ARA
BACK**



The Serial Number is located near the bottom right side of the ARA back label. The Serial Number is 2 Letters followed by 8 Numbers.



The Serial Number is located in the same place for all ARA models.

3. Fixed Gas and Leak Detectors

Falco & Falco TAC Diffused:



Falco models after Serial Number 000920/08/19 will have the Serial Number label at the back of the instrument.
6 numbers / 2 numbers / 2 numbers.
XXXXXX/XX/XX

Falco models before Serial Number 000919/08/19 will have the Serial Number at the front right side of the instrument.
6 numbers / 2 numbers / 2 numbers.
XXXXXX/XX/XX



Serial Number.

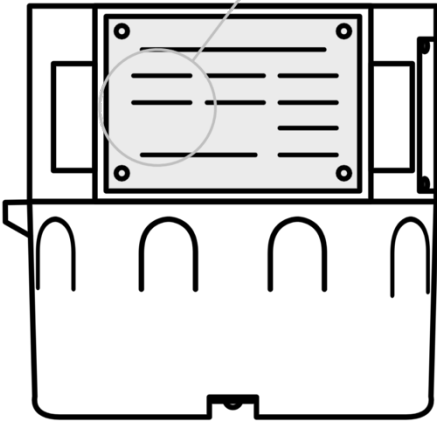

FALCO TOP

Please note: With previous models of the Falco the label may be on the side or the back of the instrument, it will still look the same and the Serial Number is located in the same area on the label

Falco & Falco TAC Pumped:



Falco models after Serial Number 100509/08/19 will have the Serial Number label at the back of the instrument.
6 numbers / 2 numbers / 2 numbers.
XXXXXX/XX/XX

Falco models before Serial Number 100508/08/19 will have the Serial Number at the front right side of the instrument.
6 numbers / 2 numbers / 2 numbers.
XXXXXX/XX/XX



Serial Number.

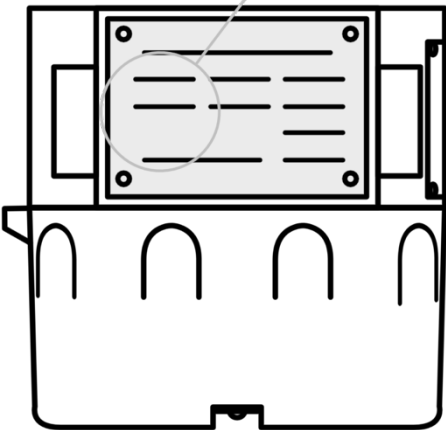

**FALCO
TOP**

Please note: With previous models of the Falco the label may be on the side or the back of the instrument, it will still look the same and the Serial Number is located in the same area on the label

Titan 1 & 2:



The Serial Number is located on the front face label of the Titan. TN- 6 numbers / 2 numbers / 2 numbers (TN-XXXXXX/XX/XX)

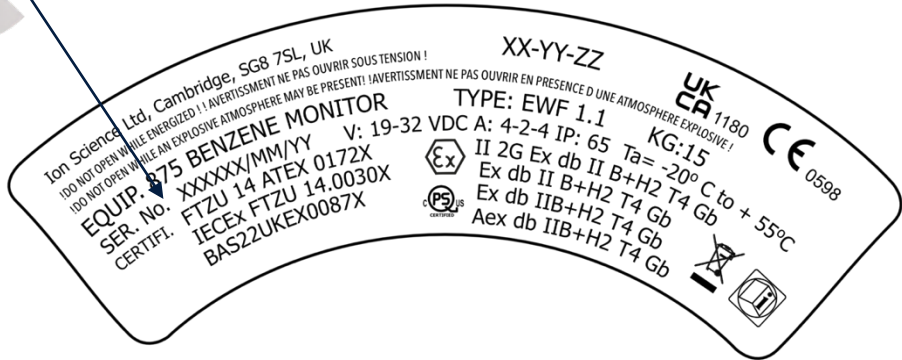

The Service Module Serial Number is located behind the front plate of the Titan and reads TSM-6 numbers. (TSM – XXXXXX) and the Titan 2 Module reads T2SM-6 numbers (T2SM – XXXXXX)

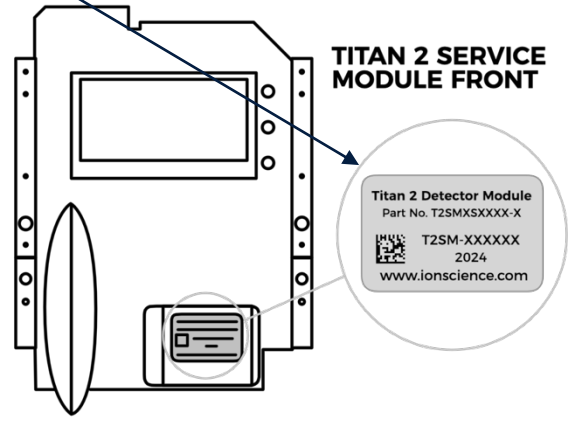
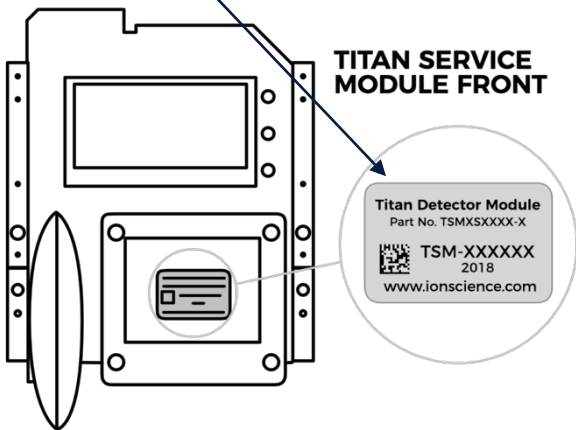

TVOC 2:



The Serial Number is located on the front face label of the TVOC 2. 2 numbers – 5 numbers. (XX-XXXXX)

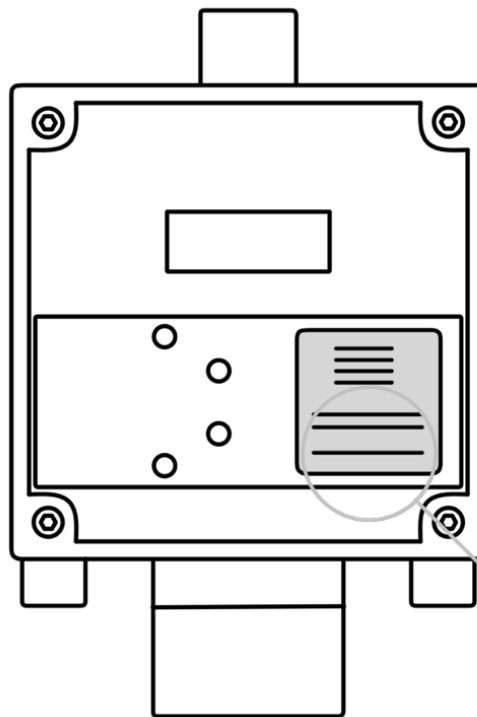

**TVOC
FRONT
PANEL**



4. Semi-Portable Gas Detectors

GasClam 2:



There are two silver plates with information on at the larger end of the GasClam 2. The Serial Number is on the same silver plate label as battery information and certifications.
6 numbers / 2 numbers / 2 numbers.
XXXXXX/XX/XX

